

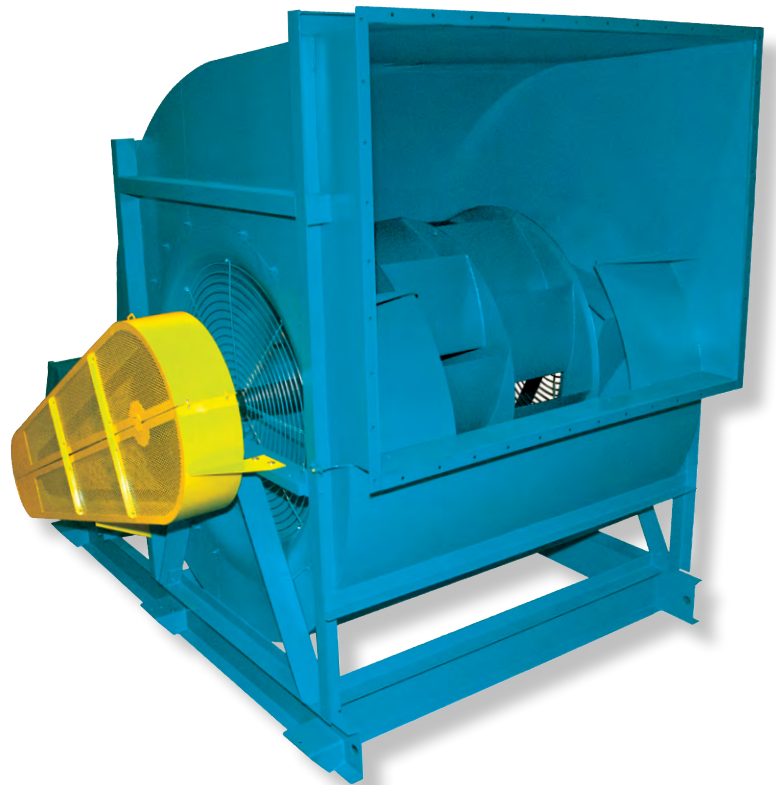

INDUSTRIAL PROCESS AND
COMMERCIAL VENTILATION SYSTEMS

AEROFOIL FANS

BAE-SWSI | BAE-DWDI





BAE SWSI
Arrangement 9

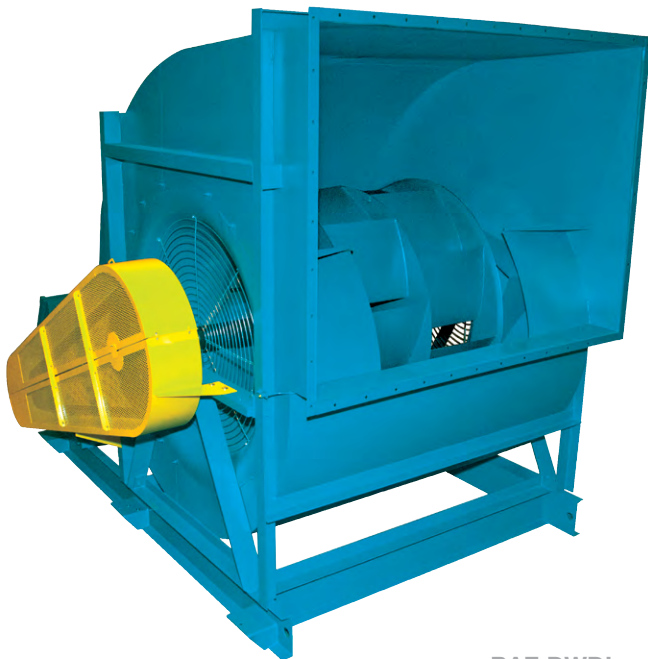

BAE DWDI
Arrangement 3



Twin City Fan & Blower certifies that the Model BAE SWSI and BAE DWDI fans shown herein are licensed to bear the AMCA Seal. The ratings shown are based on tests and procedures performed in accordance with AMCA Publication 211 and comply with the requirements of the AMCA Certified Ratings Program.

Refer to Catalogue 375 for sound power levels.

Models

BAE SWSI & BAE DWDI Featuring the E-Series Impeller

This catalogue features the new BAE aerofoil impeller design. It includes both the SWSI (single width, single inlet) and the DWDI (double width, double inlet) designs. The newly designed aerofoil blades offer higher efficiencies and better sound characteristics than our previous designs.

Please discuss your particular application with the Twin City Fan & Blower representative for your area.

Twin City Fan & Blower has established itself as a leader in the design and manufacture of quality air moving equipment and continues to advance by implementing a philosophy that stresses quality in all of its operations. Our products are known for their rugged construction and reliability of operation. Twin City Fan & Blower offers flexibility in design and construction of fans coupled with superior service before and after the sale.

Model BAE SWSI

Sizes

311 mm to 2495 mm impeller diameters

Performance

Airflow to 110 m³/sec
Static pressure to 5000 Pa

Arrangements

Available in Arrangements 1, 3, 4, 8, 9, 9F, 10

Model BAE DWDI

Sizes

311 mm to 2495 mm impeller diameters

Performance

Airflow to 198 m³/sec
Static pressure to 3500 Pa

Arrangements

Available in Arrangements 3, 3F

Impeller Construction

High efficiency, non-overloading aerofoil impellers are provided on all sizes and arrangements. Impellers shall have precision spun, flat inlet cones to allow higher efficiencies over the performance range of the fan. Aluminium impellers using extruded aluminium blades are provided as standard on sizes 245 and smaller and are available as an option on larger units.

The BAE-DW impellers shall have staggered blades for improved sound characteristics. All hollow blade impellers shall be continuously welded around all edges. All impellers shall be statically and dynamically balanced on precision electronic balancers to a Balance Quality Grade G6.3 (3.8 mm/s rms) per ANSI/AMCA 204 or better.

Housing Construction

All fan housings are continuously welded to provide strength and durability for extended service life — a necessity in all commercial and industrial installations.

All housings are reinforced with rigid bracing to increase structural integrity. The support angles are intermittently welded and caulked between welds to prevent bleed-through corrosion. Precisely positioned cut-off plates and aerodynamically spun inlet cones provide high efficiency and smooth airflow through the fan. The housing construction and dimensions are exactly the same as our current BAF fan design.

All fans are available in standard discharge configuration. BAE-SW fans Class I and II, sizes 270 and smaller in Arrangements 1, 4, and 9 are field rotatable to any standard discharge position. To help reduce overall heights, all BAE-DW fans feature a non-rotatable housing design as standard.

Shaft

Shafts are AISI Grade 1040 or 1045 hot-rolled steel accurately turned, ground, polished, and ring gauged for accuracy. Shafts are generously sized for a first critical speed of at least 1.43 times the maximum speed for the class.

Bearings

Bearings are heavy duty, grease lubricated, spherical roller or anti-friction ball (BAE-DW bearings are adapter mounted), self-aligning, pillow block type, selected for minimum average bearing life L10 in excess of 40,000 hours at the maximum fan RPM.

Mechanical Run Test & Final Vibration Check

All fans are assembled for a mechanical run test and final balance prior to shipment. Vibration readings are taken on both fan bearings in the axial, horizontal, and vertical directions at the specified speed. Fans are balanced to 3.8 mm/s. peak or less (G6.3 specification).



BAE-DW impeller with hollow aerofoil blades staggered for improved sound quality



BAE-SW impeller with hollow aerofoil blades continuously welded to the rim and backplate





Arrangement 1 fan with optional unitary base, pie-shaped split housing, shaft and V-belt drive guard.

Arrangement 1 SWSI — Single Width, Single Inlet

Arrangement 1 fans are usually belt driven. The impeller is overhung on the shaft, i.e., mounted at the end of the shaft. The motor can be mounted in any of the four AMCA standard motor positions, W, X, Y, or Z. The two fan bearings are mounted on the bearing pedestal, out of the airstream. Arrangement 1 fans are thus recommended for high temperature or contaminated air applications. Belt driven configurations offer performance flexibility. If the performance requirements change after the fan has been installed, it is simple and inexpensive to change the drive.

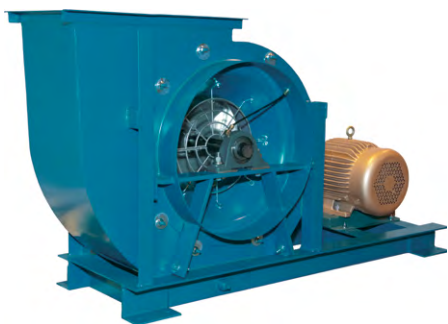

Extended lube line at inlet — standard on all Arrangement 3 fans.

Arrangement 3 SWSI — Single Width, Single Inlet

Arrangement 3 is available in belt driven only. Arrangement 3 SWSI has one bearing located in the airstream. The impeller is mounted between the bearings and supported by the fan housing, which makes it a structurally sound, compact, and economical arrangement.



Direct drive Arrangement 4 with shaft seal.

Arrangement 4 SWSI — Single Width, Single Inlet

Arrangement 4 is available in direct drive only. The fan impeller is mounted directly on the motor shaft with the motor mounted on a pedestal. An Arrangement 4 design offers low maintenance as there are no fan bearings, fan shaft or drive parts to maintain. Arrangement 4 is typically limited to size 365 or smaller. With no drive losses, arrangement 4 is an energy efficient solution.

Typical Direct Drive Speeds

60 Hz OPERATION		50 Hz OPERATION	
Synchronous Speed	Full Load Speed	Synchronous Speed	Full Load Speed
3600	3500	3000	2900
1800	1750	1500	1450
1200	1170	1000	975
900	870	750	725

The actual full load speed of the motor can vary slightly depending upon motor HP, motor design and motor manufacturer.

Arrangement 8 fan with optional coupling and horizontal split housing.

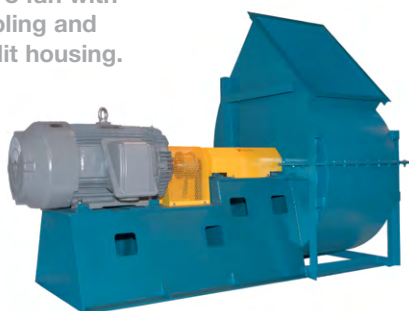

Arrangement 8 SWSI — Single Width, Single Inlet

Arrangement 8 is a modified version of Arrangement 1 used for direct drive. The Arrangement 1 bearing pedestal is extended to accommodate the motor. A flexible coupling connects the fan and motor shaft. Refer to the typical direct drive speeds under Arrangement 4. Recommended for 185 kW and larger applications.

Arrangement 9

SWSI — Single Width, Single Inlet

Arrangement 9 is available as belt driven only. A motor slide base is mounted on the side of the bearing pedestal. This arrangement permits the unit to ship as a complete assembly with the motor and drive mounted. Typically, the motor is mounted on the left side of the pedestal for CW rotation fans and on the right side for CCW rotation fans.

Arrangement 9F

SWSI — Single Width, Single Inlet (Not Shown)

Arrangement 9F is available when a unit requires a motor that is too large to mount on the side of the bearing pedestal. The fan base is extended to accommodate the motor, for horizontal mounting, similar to an Arrangement 1 fan. Typically, the motor is mounted on the left side of the pedestal for CW rotation fans and on the right side for CCW rotation fans. Arrangement 9F is not suitable for mounting vibration isolators directly under the fan.



Fan shown is Arrangement 9 CW-THD with non-standard motor location on right-hand side.

Arrangement 10

SWSI — Single Width, Single Inlet

Arrangement 10 is available in sizes from 122 through 600 as belt driven only. An Arrangement 10 unit has an adjustable motor base mounted inside the bearing pedestal. This arrangement offers a more compact design than the Arrangement 9 and is suitable for roof or outdoor installations with a weather cover. For Class I and II fans, sizes 122 through 365, Arrangement 10 units are commonly referred to as Ventilating Sets. (Refer to Catalogue 600 for more details.)



Class II Arrangement 10 ventilating set with optional shaft cooler and insulated heat shield.

DWDI ARRANGEMENTS

Arrangement 3

DWDI fans are generally supplied in Arr. 3 for V-belt drive. The impeller is mounted between the bearings and supported by the fan housing. Since both bearings are located in the airstream, standard DWDI fans should be used for clean air applications with air temperatures limited to 50°C. The motor can be mounted in any of the four standard motor positions: W, X, Y or Z.

Arrangement 3F (Not Shown)

Arr. 3F offers an integral extended base to accommodate the motor. The base is pre-punched to accept vibration isolators. Arr. 3F is available to Size 660 and for motor positions W and Z as standard. For motor positions X and Y, consult factory.



Arr. 3 on isolation base with motor located in "Z" position.

Spark Resistant Construction

Fan applications may involve the handling of potentially explosive or flammable particles, fumes or vapors. Such applications require careful consideration by the system designer to insure the safe handling of such gases. Twin City Fan & Blower offers the following classifications of spark resistant construction per AMCA Standard 99-0401. It is the specifier or the user's responsibility to specify the type of spark resistant construction with full recognition of the potential hazards and the degree of protection required.

- Type A All parts of the fan in contact with the air-stream must be made of non-ferrous material — usually aluminium and limited to 120°C operation.
- Type B The fan shall have a non-ferrous impeller and non-ferrous ring about the opening through which the shaft passes — usually aluminium impeller and anti-spark track and limited to 120°C construction.
- Type C The fan shall be so constructed that the shift of the impeller or shaft will not permit two ferrous parts of the fan to rub or strike. This is accomplished with an aluminium inlet cone and anti-spark track. This construction is limited to 260°C. Construction to 425°C is available using a steel inlet cone with copper/bronze lining.

Notes:

1. Bearings shall be placed outside the airstream. Therefore, spark resistant construction is not available on Arrangement 3 or 7.
2. The user shall electrically earth all fan parts.

Refer to the above listed AMCA standard for full details.

Special Metals

To suit the demanding applications of today's industry, Twin City Fan & Blower offers a variety of material for construction, including aluminium and stainless steel. We offer AWS and ASME certified welding procedures and welding technicians to assure quality construction when using special metals as well.

Split Housings

All fans are designed to permit impeller removal through the fan inlet. To suit installation as well as transportation requirements, Twin City Fan & Blower offers horizontal split, pie-shaped, as well as other special split housing designs. Pie-shaped split housings allow fan impeller and shaft removal without disconnecting ductwork.



Arrangement 8 fan with horizontal split housing with bolted access door

Swingout Construction

Swingout fans are ideal for applications requiring frequent cleaning and inspection of the fan impeller and interior of the housing such as found in spray painting booth exhaust. Refer to Catalogue GA200 for other types of easy access fans offered by Twin City Fan & Blower.

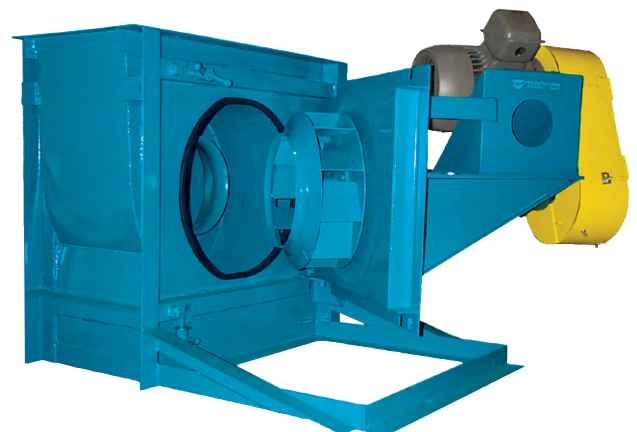

Designation for Rotation and Discharge

Direction of rotation is determined from drive side of the fan.
 On single inlet fans, the drive side is always considered the side opposite the fan inlet.
 On double inlet fans with drives on both sides, the drive side is that with the higher power drive unit.
 The direction of discharge is determined in accordance with the diagrams shown above. The angle of discharge references the vertical axis of the fan and is designated in degrees above or below that reference axis.
 On fans inverted for ceiling suspension or side-wall mounting, the discharge is determined when the fan is resting on the floor.

Motor Positions

The drawing above illustrates the AMCA motor position standards for Arrangement 1 and 3 fans (Arrangement 1 shown). The location of the motor is determined by facing the drive side of the fan and designating the motor position by letters W, X, Y, or Z, in accordance with the diagram shown above.

Illustrations reprinted from AMCA Publication 99 Standards Handbook, with the express written permission from the Air Movement and Control Association International, Inc., 30 West University Drive, Arlington Heights, IL 60004-1983.



Nestled Inlet Vanes



External Inlet Vanes

Performance Curves
at Different Vane Settings

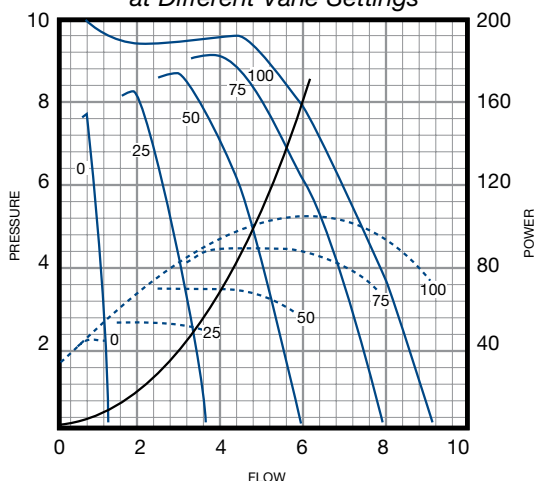

System Curve ———
 SP @ Vane Setting ———
 BHP @ Vane Setting - - - -



Parallel Blade
Outlet Damper



Opposed Blade
Outlet Damper

Volume Control Devices

Outlet dampers, variable inlet vanes, and variable frequency drives are three popular devices used to control volume for fan systems.

Variable Inlet Vanes

Variable inlet vanes cause the entering air to spin in the direction of impeller rotation, resulting in reduction in volume, static pressure and absorbed power and thus providing an infinite number of fan curves approximately parallel to the original fan curve. Variable inlet vanes cost about 50% to 80% more than outlet dampers but offer significant savings in energy. Because of their simplicity, inlet vanes can be more reliable when compared to variable frequency drives.

There are two types of variable inlet vanes: nested (internal type) and bolted on (external type).

Nestled inlet vanes are built into the fan inlet cone and offer the advantage of saving space and lower cost as opposed to the external type. They are available on all fan sizes 165 and larger. Twin City Fan & Blower offers cantilevered vanes to size 890 Class II fans to minimize insertion losses and noise associated with centre hub design.

External inlet vanes are bolted to the inlet of the fan and are available from size 122 through size 890. Use of external vanes should be considered for hostile environments since operating linkages are shielded from the airstream. Both types of inlet vanes are available to 300°C construction.

Outlet Dampers

The closing of the damper adds to the resistance that the fan is working against. This moves the operating point to the left of the initial rating point. The savings in power depends on the relative position on the fan curve and is usually much less than offered by other methods. Outlet dampers are typically the least expensive option and should be considered when infrequent operation at lesser capacity is desired or when handling hot, humid or particulate laden air.

There are two types of outlet dampers: parallel blade and opposed blade.

Parallel blade dampers are recommended for systems where air volume is modulated between full-open to about 75% of open.

Opposed blade dampers cost about 10% more and are recommended for systems where volume is modulated over the entire range. Opposed blades reduce air volume in a closer relationship to the control arm movement.

Variable Frequency Drive (VFD)

A VFD changes the fan speed and can provide the greatest potential for energy savings, although at highest initial cost. A VFD should be considered for extended operation at part load conditions, especially below 70% of the full volume operation.

Access Doors

Bolted, quick opening, and raised bolted access doors are available for impeller inspection or maintenance.

Drain

Threaded pipe coupling welded to the lowest point in the housing scroll. All fans come with a drain hole in the bottom of the housing.

Shaft Seal

A shaft seal reduces leakage and protects the bearings from a contaminated airstream. It is constructed of non-asbestos woven fibrous materials (ceramic felt) compressed between an aluminium cover plate and the fan housing. A ceramic felt shaft seal does not make the fan gas tight. A variety of special seals is available for low leakage applications requiring more positive protection, including mechanical type stuffing boxes.

Flanged Inlet

A punched inlet flange is available for duct mounting.

Flanged Outlet (DWDI Class I & II)

A punched or un-punched flange is welded to the fan outlet. An un-punched flanged outlet is standard on all SWSI and DWDI Class III and IV fans.

Inlet/Outlet Companion Flanges

Companion flanges are used for installing the fan to flexible sleeve connections and are punched to match the fan's inlet or outlet.

Inlet and Outlet Screens

Safety screens are available for mounting in the fan inlet or outlet in non-ducted applications.

Special Paint & Protective Coatings

Twin City Fan & Blower has an in-house, specialty coating facility to handle any type of coating requirement. Refer to Engineering Supplement ES-35 for more details.

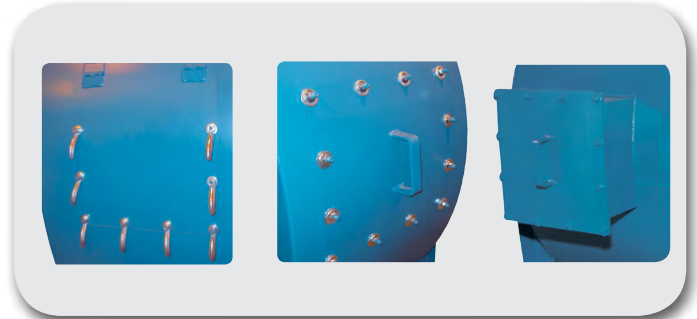

Quick-Open
Access Door

Bolted
Access Door

Raised Bolted
Access Door



Extended Drain with Plug



Shaft Seal



Safety Screen



Companion Inlet Flange

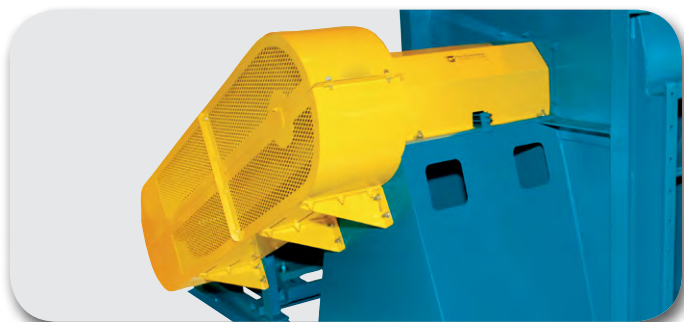

Belt, Bearing and Shaft Guard

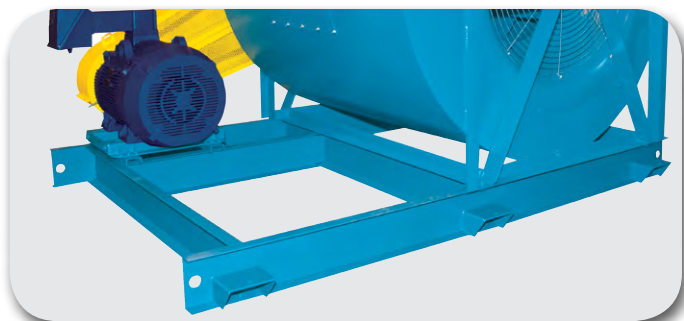

Unitary Base



Inlet Box

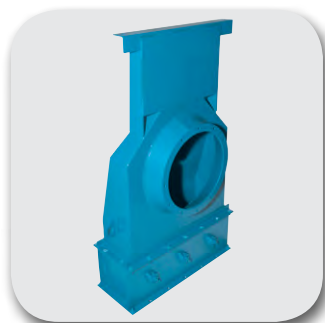

Inlet Box with Shutter

Other Accessories Available

- Variation in impeller diameter and width
- Inlet boxes
- Bearings RTD
- Piezometer ring airflow measuring system
- Consult factory for other accessories

Belt Guards

A belt guard protects personnel from the moving drive parts. Both standard and totally enclosed type guards are available.

Shaft and Bearing Guards (SWSI)

Solid sheet metal guards cover shaft and bearings and come with extended lube lines to a common point out either side of the guard. A guard spanning the shaft between the bearings is also available to provide easy access to bearings for lubrication and vibration monitoring.

Unitary Base

A structural steel base provides common support to fan, motor and drive including guards. This style of base is designed for use without isolators and requires adequate foundation integrity for proper operation.

Vibration Isolation Bases

Heavy structural base for fan, motor and drive is designed for use with spring or rubber-in-shear type isolators. Use of flexible connectors at inlet and outlet is required on fans with isolators.

V-Belt Drives

V-belt drives offer an economical yet flexible means of transmitting power to the fans. There are two types of V-belt drives.

- **Adjustable Pitch or Variable Speed Drives**

An adjustable pitch drive offers easy adjustment of speed. The motor pulley pitch can be adjusted when the fan is at rest which can offer speed variation of about 10% from the design speed. This style of sheave can result in higher vibration so adjustable pitch drives are not recommended for use on motors over 7.5 kW or wherever low vibration is required.

- **Fixed Pitch or Constant Speed Drives**

This type of drive offers low cost and lowest vibration levels. Speed change can often be accomplished by changing only one of the sheaves.

Bearing Upgrades

Unit roller or split pillow block, double row roller bearings are available. Split pillow block roller bearings are not available for fans with less than 36 mm diameter bearings and are not recommended for fans with light loadings. Refer to Engineering Data Letters FE-1200 and FE-1300 for the correct type of bearings, selection criteria, maintenance, etc.

Piezometer Ring (Airflow Measuring System)

A piezometer ring is available on model BAE fans, as well as other Twin City Fan housed and plenum fans, as part of an airflow measuring system, based on the principle of a flow nozzle. The inlet cone of the fan is used as the flow nozzle. The flow can be calculated by measuring the pressure drop through the inlet cone. No tubes or sensors are inserted in the high velocity airstream which could obstruct airflow.

The system, consists of a piezometer ring mounted at the throat and a static pressure tapping mounted on the face of the inlet cone. A differential pressure transducer and digital display can also be provided.

The pressure drop is measured from the tapping located on the face of the inlet cone to the piezometer ring in the throat. The inlet tapping is connected to the high-pressure side of the transducer and the piezometer ring is connected to the low-pressure side. Based on Twin City Fan laboratory tests, the system was determined to be accurate within +/-5%.

Refer to Twin City Fan Engineering Supplement ES-105.

Piezometer Ring Mounted at Throat of Inlet Cone

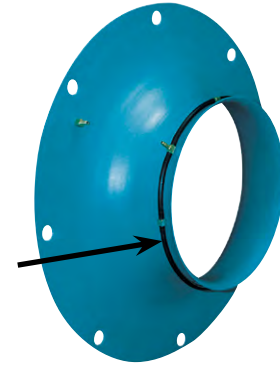

NOTE: Twin City Fan does not recommend placement of flow measuring probes inside the fan inlet cone in the path of airflow. These devices create disturbances and unpredictable performance losses. Twin City Fan will not be responsible for loss of performance due to such devices.

PERFORMANCE CORRECTION FOR TEMPERATURE & ALTITUDE

The performance curves in this catalogue are based on fans handling standard air at a density of 1.2 kg/m³. This is equivalent to air at 21°C at sea level (101.325 kPa barometric pressure). When specified performance is at a density different than standard, it must be converted to the equivalent standard conditions before

the fan can be selected from the performance curves. The equivalent standard conditions can be calculated by using the Temperature and Altitude Density Ratios shown in the table below.

Temperature and Altitude Density Ratios

AIR TEMP °C	ALTITUDE IN METRES ABOVE SEA LEVEL											
	0	300	600	900	1200	1500	1750	2000	2400	2800	3500	4500
	BAROMETRIC PRESSURE IN kPa											
	101.32	97.77	94.32	90.97	87.71	84.55	81.99	79.49	75.62	71.91	65.76	57.73
-40	1.258	1.214	1.171	1.129	1.089	1.050	1.018	0.987	0.939	0.893	0.816	0.717
-20	1.158	1.117	1.078	1.040	1.002	0.966	0.937	0.909	0.864	0.822	0.752	0.660
10	1.035	0.999	0.963	0.929	0.896	0.864	0.838	0.812	0.772	0.735	0.672	0.590
20	1.000	0.965	0.931	0.898	0.866	0.835	0.809	0.785	0.746	0.710	0.649	0.570
40	0.936	0.903	0.871	0.840	0.810	0.781	0.757	0.734	0.699	0.664	0.608	0.533
65	0.867	0.837	0.807	0.778	0.751	0.724	0.702	0.680	0.647	0.615	0.563	0.494
100	0.786	0.758	0.732	0.706	0.680	0.656	0.636	0.617	0.587	0.558	0.510	0.448
125	0.736	0.710	0.685	0.661	0.637	0.614	0.596	0.577	0.549	0.522	0.478	0.419
150	0.693	0.669	0.645	0.622	0.600	0.578	0.561	0.544	0.517	0.492	0.450	0.395
175	0.654	0.631	0.609	0.587	0.566	0.546	0.529	0.513	0.488	0.464	0.424	0.373
200	0.619	0.597	0.576	0.556	0.536	0.517	0.501	0.486	0.462	0.439	0.402	0.353
225	0.588	0.567	0.547	0.528	0.509	0.491	0.476	0.461	0.439	0.417	0.382	0.335
250	0.560	0.540	0.521	0.503	0.485	0.467	0.453	0.439	0.418	0.397	0.363	0.319
275	0.535	0.516	0.498	0.480	0.463	0.446	0.433	0.420	0.399	0.380	0.347	0.305
300	0.511	0.493	0.476	0.459	0.442	0.426	0.414	0.401	0.381	0.363	0.332	0.291
350	0.470	0.454	0.438	0.422	0.407	0.392	0.380	0.369	0.351	0.334	0.305	0.268
375	0.452	0.436	0.421	0.406	0.391	0.377	0.366	0.355	0.337	0.321	0.293	0.258
400	0.435	0.420	0.405	0.391	0.377	0.363	0.352	0.341	0.325	0.309	0.282	0.248
425	0.420	0.405	0.391	0.377	0.364	0.350	0.340	0.330	0.313	0.298	0.273	0.239
450	0.405	0.391	0.377	0.364	0.351	0.338	0.328	0.318	0.302	0.287	0.263	0.231
500	0.379	0.366	0.353	0.340	0.328	0.316	0.307	0.297	0.283	0.269	0.246	0.216
550	0.356	0.344	0.331	0.320	0.308	0.297	0.288	0.279	0.266	0.253	0.231	0.203
600	0.336	0.324	0.313	0.302	0.291	0.280	0.272	0.264	0.251	0.238	0.218	0.191

Maximum RPM, Impeller Weights & WR² (moment of inertia in kg-m²)

SWSI

SIZE	SW ALUMINUM											
	CLASS I			CLASS II			CLASS III			CLASS IV		
	MAX. RPM	IMPELLER WEIGHT (kg)	WR ² (kg-m ²)	MAX. RPM	IMPELLER WEIGHT (kg)	WR ² (kg-m ²)	MAX. RPM	IMPELLER WEIGHT (kg)	WR ² (kg-m ²)	MAX. RPM	IMPELLER WEIGHT (kg)	WR ² (kg-m ²)
122	3990	4.3	0.04	5206	4.3	0.04	NA	NA	NA	NA	NA	NA
135	3256	4.6	0.06	4260	4.6	0.06						
150	3260	6.2	0.09	4253	6.2	0.09						
165	2673	7.1	0.14	3487	7.6	0.17						
182	2207	7.7	0.26	2879	8.2	0.26	3628	9.5	0.26			
200	2014	9.5	0.27	2627	9.5	0.31	3310	10.9	0.39			
222	1814	13.6	0.51	2367	13.6	0.51	2982	15.5	0.63			
245	1647	15.9	0.88	2149	15.9	0.88	2708	17.3	0.93			
270	1474	18.2	1.2	1923	18.2	1.2	2423	21.4	1.3			
300	1327	22.3	1.9	1731	24.5	2.1	2181	26.4	2.2			
330	1206	28.2	2.9	1573	30.5	3.2	1982	32.7	3.2			
365	1080	33.2	4.3	1409	35.9	4.7	1775	38.2	4.8			
402	979	38.6	6.4	1278	42.3	7.0	1610	44.5	7.0			
445	886	57.3	9.8	1156	61.4	10.7	1456	64.5	10.8			
490	804	74.5	16.5	1050	74.5	16.5	1322	79.1	22.5			
542	727	103	26.6	948	103	26.6	1194	109	28.4			
600	657	116	39.2	857	116	39.2	1080	123	41.8			
660	597	157	58.0	779	157	58.0	982	169	62.3			
730	540	187	86.3	705	227	113	888	250	126			
807	488	227	127	637	261	146	NA	NA	NA	NA	NA	NA
890	443	352	238	578	402	271						
982	401	411	348	523	473	398						

SIZE	SW STEEL											
	CLASS I			CLASS II			CLASS III			CLASS IV		
	MAX. RPM	IMPELLER WEIGHT (kg)	WR ² (kg-m ²)	MAX. RPM	IMPELLER WEIGHT (kg)	WR ² (kg-m ²)	MAX. RPM	IMPELLER WEIGHT (kg)	WR ² (kg-m ²)	MAX. RPM	IMPELLER WEIGHT (kg)	WR ² (kg-m ²)
122	NA	NA	NA	NA	NA	NA	NA	NA	NA	NA	NA	NA
135												
150												
165												
182												
200												
222												
245												
270	1474	45.0	2.9	1923	45.0	2.9	2423	55.0	3.5	2756	61.4	3.8
300	1327	56.4	4.5	1731	56.4	4.5	2181	67.3	5.2	2480	72.7	5.8
330	1206	68.6	6.8	1573	68.2	6.8	1982	84.1	7.7	2255	90.5	8.6
365	1080	99.1	11.6	1409	98.2	12	1775	114	12.3	2040	114	12.9
402	979	115	16.9	1278	114	16.9	1610	131	19.0	1850	131	18.7
445	886	155	26.1	1156	154	26.1	1456	199	34.3	1673	211	35.7
490	804	178	37.7	1050	177	37.7	1322	242	53.0	1520	256	55.1
542	727	258	60.0	948	276	65.0	1194	335	87.1	1373	368	95.3
600	657	316	94.6	857	317	94.6	1080	389	126	1241	428	141
660	597	428	144	779	433	144	982	515	189	1128	561	212
730	540	496	222	705	501	222	888	632	304	1020	685	329
807	488	585	327	637	635	356	802	735	447	922	799	485
890	443	880	595	578	882	595	728	1070	765	837	1135	819
982	401	1020	863	523	1026	863	654	1350	1229	NA	NA	NA

Maximum RPM, Impeller Weights & WR² (moment of inertia in kg-m²)

DWDI

SIZE	DW ALUMINUM											
	CLASS I			CLASS II			CLASS III			CLASS IV		
	MAX. RPM	IMPELLER WEIGHT (kg)	WR ² (kg-m ²)	MAX. RPM	IMPELLER WEIGHT (kg)	WR ² (kg-m ²)	MAX. RPM	IMPELLER WEIGHT (kg)	WR ² (kg-m ²)	MAX. RPM	IMPELLER WEIGHT (kg)	WR ² (kg-m ²)
122	3957	6.4	0.05	5158	6.6	0.05	NA	NA	NA	NA	NA	NA
135	3374	6.7	0.07	4398	8.0	0.07						
150	3232	9.9	0.10	4213	10.8	0.10						
165	2761	11.4	0.16	3599	12.6	0.19						
182	2248	13.2	0.44	2930	13.2	0.42	3695	15.0	0.41			
200	2051	16.4	0.46	2674	18.2	0.59	3372	17.7	0.64			
222	1837	20.5	0.76	2395	24.1	0.88	3020	24.5	1.0			
245	1668	24.1	1.3	2175	28.2	1.6	2742	27.3	1.5			
270	1541	28.2	1.9	2009	31.4	2.1	2533	34.1	2.1			
300	1387	36.4	3.2	1808	39.1	3.4	2280	40.5	3.4			
330	1261	49.1	5.1	1644	51.8	5.4	2072	47.3	4.7			
365	1114	49.5	6.5	1452	55.9	7.3	2831	54.1	6.8			
402	1010	60.5	9.9	1317	65.5	10.8	1661	64.1	10.1			
445	914	86.8	14.9	1191	101	17.5	1502	100	16.6			
490	830	111	24.6	1082	118	26.1	1364	119	34.0			
542	750	154	39.8	977	153	39.6	1232	164	42.7			
600	678	173	58.5	883	171	57.8	1114	182	61.9			
660	616	225	83.1	803	227	83.7	1013	244	90.2			
730	557	270	124	726	325	161	916	375	189			
807	504	330	185	656	372	209	NA	NA	NA	NA	NA	NA
890	457	514	348	596	589	397						
982	414	609	515	539	700	589						

SIZE	DW STEEL											
	CLASS I			CLASS II			CLASS III			CLASS IV		
	MAX. RPM	IMPELLER WEIGHT (kg)	WR ² (kg-m ²)	MAX. RPM	IMPELLER WEIGHT (kg)	WR ² (kg-m ²)	MAX. RPM	IMPELLER WEIGHT (kg)	WR ² (kg-m ²)	MAX. RPM	IMPELLER WEIGHT (kg)	WR ² (kg-m ²)
122	NA	NA	NA	NA	NA	NA	NA	NA	NA	NA	NA	NA
135												
150												
165												
182												
200												
222												
245												
270	1541	69.1	4.9	2009	77.3	4.9	2533	88.6	5.5	2756	96.4	6.0
300	1387	91.4	7.4	1808	89.5	7.4	2280	103	8.3	2480	119	9.1
330	1261	120	11.5	1644	115	11.5	2072	122	12.2	2255	138	13.3
365	1114	148	18.5	1452	152	18.5	1831	162	18.7	2040	165	19.9
402	1010	180	27.0	1317	177	27.0	1661	190	29.5	1850	197	29.0
445	914	235	41.3	1191	253	41.5	1502	306	55.5	1673	327	58.3
490	830	266	60.1	1082	281	60.3	1364	365	86.3	1520	377	87.1
542	750	336	89.7	977	350	94.7	1232	438	133	1373	450	139
600	678	412	141	883	408	141	1114	510	194	1241	536	210
660	616	613	220	803	625	220	1013	745	299	1128	813	323
730	557	714	347	726	719	347	916	949	494	1020	972	509
807	504	853	514	656	905	545	828	1114	727	922	1151	751
890	457	1285	922	596	1292	922	751	1500	1178	837	1535	1205
982	414	1513	1346	539	1520	1346	NA	NA	NA	NA	NA	NA

Features & Weights

SWSI Class I

SIZE	HOUSING		SHAFT DIAMETER & BEARINGS				BARE FAN WEIGHT (kg)		
	SIDES	SCROLL	ARR 1 & 9		ARR 3		ARR 1	ARR 3	ARR 9
			SHAFT DIA.	BEARING TYPE	SHAFT DIA.	BEARING TYPE			
122	2.0	2.0	25	B	1	B	55.5	47.3	58.6
135	2.0	2.0	25	B	1	B	64.1	56.8	67.3
150	2.0	2.0	25	B	1	B	76.8	67.7	80.9
165	2.0	2.0	25	B	1	B	90.5	90.9	95.0
182	2.0	2.0	30	B	30	B	108	91.8	114
200	2.0	2.0	38	B	38	B	131	104	138
222	2.5	2.0	38	B	38	B	165	114	175
245	2.5	2.0	38	B	38	B	200	139	211
270	2.5	2.0	42	B	38	B	271	203	284
300	3.0	2.5	50	B	42	B	328	302	344
330	3.0	2.5	50	B	42	B	396	425	416
365	3.0	2.5	50	B	50	B	497	469	521
402	3.0	2.5	55	B	50	B	650	590	682
445	3.0	2.5	65	B	50	B	760	740	798
490	3.0	2.5	70	B	55	R	887	821	930
542	3.0	2.5	75	B	65	R	1301	1092	1364
600	3.0	2.5	75	B	75	B	1534	1485	1608
660	3.0	2.5	90	R	75	R	1944	1870	2039
730	3.0	3.0	90	R	90	R	2373	2188	2490
807	3.0	3.0	100	R	100	R	2389	2499	2507
890	5.0	3.0	100	R	100	R	3282	3031	3444
982	5.0	5.0	125	SR	125	SR	4284	3567	4495

Bearing Types: B = Ball Bearing R = Unit Roller Bearings SR = Spherical Roller Bearings with Split Pillow Block Housings

SWSI Class II

SIZE	HOUSING		SHAFT DIAMETER & BEARINGS				BARE FAN WEIGHT (kg)		
	SIDES	SCROLL	ARR 1 & 9		ARR 3		ARR 1	ARR 3	ARR 9
			SHAFT DIA.	BEARING TYPE	SHAFT DIA.	BEARING TYPE			
122	2.0	2.0	25	B	25	B	58.2	51.8	60.9
135	2.0	2.0	25	B	25	B	66.8	62.3	70.0
150	2.0	2.0	30	B	30	B	81.8	74.1	85.9
165	2.0	2.0	30	B	30	B	95.9	99.5	100
182	2.0	2.0	38	B	38	B	114	100	120
200	2.0	2.0	38	B	38	B	134	114	141
222	2.5	2.0	38	B	38	B	170	127	179
245	2.5	2.0	42	B	42	B	210	155	222
270	2.5	2.0	42	B	42	B	277	222	291
300	3.0	2.5	50	B	50	B	330	326	346
330	3.0	2.5	55	B	55	B	400	453	420
365	3.0	2.5	65	B	65	B	515	498	540
402	3.0	2.5	65	R	65	B	663	633	696
445	3.0	2.5	70	R	70	R	764	784	802
490	3.0	2.5	70	R	70	R	890	867	935
542	3.0	2.5	90	R	75	R	1338	1171	1403
600	3.0	2.5	90	R	90	R	1559	1599	1635
660	3.0	2.5	100	R	100	R	2020	2035	2120
730	3.0	3.0	100	R	100	R	2461	2411	2583
807	3.0	3.0	115	SR	115	R	2501	2755	2625
890	5.0	3.0	125	SR	125	R	3464	3338	3634
982	5.0	5.0	140	SR	140	SR	4384	3907	4600

Bearing Types: B = Ball Bearing R = Unit Roller Bearings SR = Spherical Roller Bearings with Split Pillow Block Housings

Features & Weights

SWSI Class III

SIZE	HOUSING		SHAFT DIAMETER & BEARINGS				BARE FAN WEIGHT (kg)		
	SIDES	SCROLL	ARR 1 & 9		ARR 3		ARR 1	ARR 3	ARR 9
			SHAFT DIA.	BEARING TYPE	SHAFT DIA.	BEARING TYPE			
122	NA								
135									
150									
165									
182									
182	3.0	3.0	42	B	42	B	124	171	130
200	3.0	3.0	50	B	42	B	144	186	152
222	3.0	3.0	50	B	50	R	185	202	196
245	5.0	5.0	55	B	50	R	260	222	275
270	5.0	5.0	55	B	50	R	347	299	364
300	5.0	5.0	65	R	55	R	449	486	471
330	5.0	5.0	70	R	65	R	546	494	574
365	5.0	5.0	70	R	65	R	650	678	682
402	5.0	5.0	75	R	70	R	808	849	849
445	5.0	5.0	90	R	75	R	1011	1070	1061
490	5.0	5.0	90	R	75	R	1198	1229	1257
542	5.0	5.0	100	R	90	R	1719	1595	1802
600	5.0	5.0	115	SR	100	R	2155	2158	2260
660	5.0	5.0	115	SR	100	R	2556	2858	2680
730	5.0	5.0	125	SR	115	SR	3089	3352	3240
807	5.0	5.0	125	SR	125	SR	3061	3822	3212
890	5.0	5.0	140	SR	140	SR	3688	4565	3870

Bearing Types: B = Ball Bearing R = Unit Roller Bearings SR = Spherical Roller Bearings with Split Pillow Block Housings

SWSI Class IV

SIZE	HOUSING		SHAFT DIAMETER & BEARINGS				BARE FAN WEIGHT (kg)											
	SIDES	SCROLL	ARR 1 & 9		ARR 3		ARR 1	ARR 3	ARR 9									
			SHAFT DIA.	BEARING TYPE	SHAFT DIA.	BEARING TYPE												
122	NA																	
135																		
150																		
165																		
182																		
200																		
222																		
245																		
270										5.0	5.0	65	R	55	R	401	332	421
300										5.0	5.0	70	R	65	R	505	536	531
330	6.0	6.0	75	R	70	R	694	734	729									
365	6.0	6.0	90	R	75	R	899	760	944									
402	6.0	6.0	90	R	75	R	1102	944	1158									
445	6.0	6.0	100	R	90	R	1409	1201	1478									
490	6.0	6.0	100	R	90	R	1621	1361	1701									
542	6.0	6.0	115	SR	100	R	2136	1765	2240									
600	6.0	6.0	125	SR	115	SR	2547	2372	2673									
660	6.0	6.0	125	SR	115	SR	3075	3165	3227									
730	6.0	6.0	140	SR	125	SR	3770	3684	3957									
807	6.0	6.0	140	SR	140	SR	3664	4193	3847									
890	6.0	6.0	enq	SR	enq	SR	4355	5005	4572									

Bearing Types: B = Ball Bearing R = Unit Roller Bearings SR = Spherical Roller Bearings with Split Pillow Block Housings

Features & Weights

DWDI Class I & II

SIZE	HOUSING		SHAFT DIAMETER & BEARINGS						BARE FAN WEIGHT (kg)	
	SIDES	SCROLL	CLASS I			CLASS II			ARR 3	
			SHAFT DIAMETER		BEARING TYPE	SHAFT DIAMETER		BEARING TYPE	CLASS I	CLASS II
@ BRG.	@ IMPELLER	@ BRG.	@ IMPELLER							
122	2.0	2.0	30	30	B	38	38	B	66	72
135	2.0	2.0	30	30	B	42	42	B	75	82
150	2.0	2.0	38	38	B	42	42	B	91	100
165	2.0	2.0	38	38	B	50	50	B	105	115
182	2.5	2.0	42	42	B	50	50	B	127	137
200	2.5	2.0	42	42	B	55	55	B	149	159
222	2.5	2.0	50	50	B	65	65	B	192	215
245	2.5	2.0	55	55	B	65	65	B	210	240
270	2.5	2.0	55	55	B	70	70	R	312	344
300	3.0	2.5	65	65	B	65	75	R	441	465
330	3.0	2.5	65	65	B	65	90	R	503	525
365	3.0	2.5	70	70	B	70	90	R	667	707
402	3.0	2.5	65	75	R	70	90	R	838	882
445	3.0	2.5	65	90	R	75	100	R	1012	1075
490	3.0	2.5	70	90	R	90	100	R	1112	1170
542	3.0	2.5	75	100	R	90	115	R	1412	1520
600	3.0	2.5	90	115	R	100	125	R	1984	2140
660	3.0	2.5	90	115	R	100	125	R	2605	2826
730	3.0	3.0	100	125	R	100	enq	R	2921	3209
807	3.0	3.0	100	140	R	115	enq	SR	3583	3936
890	5.0	3.0	100	enq	R	115	enq	SR	4270	4748
982	5.0	5.0	125	enq	SR	140	enq	SR	5266	5801

Bearing Types: B = Ball Bearing R = Unit Roller Bearings SR = Spherical Roller Bearings with Split Pillow Block Housings

DWDI Class III & IV

SIZE	HOUSING				SHAFT DIAMETER & BEARINGS						BARE FAN WEIGHT (kg)	
	CLASS III		CLASS IV		CLASS III			CLASS IV			ARR 3	
	SIDES	SCROLL	SIDES	SCROLL	SHAFT DIAMETER		BEARING TYPE	SHAFT DIAMETER		BEARING TYPE	CLASS III	CLASS IV
@ BRG.	@ IMPELLER	@ BRG.	@ IMPELLER									
122	CONSULT FACTORY		CONSULT FACTORY		CONSULT FACTORY			CONSULT FACTORY			NA	NA
135	CONSULT FACTORY		CONSULT FACTORY		CONSULT FACTORY			CONSULT FACTORY			NA	NA
150	CONSULT FACTORY		CONSULT FACTORY		CONSULT FACTORY			CONSULT FACTORY			NA	NA
165	CONSULT FACTORY		CONSULT FACTORY		CONSULT FACTORY			CONSULT FACTORY			NA	NA
182	3.0	3.0	5.0	5.0	55	55	R	NA			198	NA
200	3.0	3.0	5.0	5.0	65	65	R	NA			268	NA
222	3.0	3.0	5.0	5.0	65	65	R	NA			341	NA
245	5.0	5.0	5.0	5.0	65	75	R	NA			369	NA
270	5.0	5.0	5.0	5.0	70	90	R	75	100	R	510	559
300	5.0	5.0	5.0	5.0	70	90	R	75	115	R	695	759
330	5.0	5.0	6.0	6.0	75	90	R	90	125	R	758	840
365	5.0	5.0	6.0	6.0	75	100	R	90	125	R	943	1058
402	5.0	5.0	6.0	6.0	90	100	R	100	140	R	1190	1319
445	5.0	5.0	6.0	6.0	90	115	R	100	140	R	1527	1707
490	5.0	5.0	6.0	6.0	100	125	R	115	140	SR	1684	1848
542	5.0	5.0	6.0	6.0	100	140	R	115	enq	SR	2104	2317
600	5.0	5.0	6.0	6.0	115	140	SR	125	enq	SR	2945	3211
660	5.0	5.0	6.0	6.0	125	enq	SR	140	enq	SR	3915	4352
730	5.0	5.0	6.0	6.0	125	enq	SR	enq	enq	SR	4545	4946
807	5.0	5.0	6.0	6.0	—	—	SR	—	—	SR	5556	5591
890	5.0	5.0	6.0	6.0	—	—	SR	—	—	SR	6612	7150
982	5.0	5.0	6.0	6.0	—	—	—	—	—	—	NA	NA

Bearing Types: B = Ball Bearing R = Unit Roller Bearings SR = Spherical Roller Bearings with Split Pillow Block Housings

BAE-SW 122

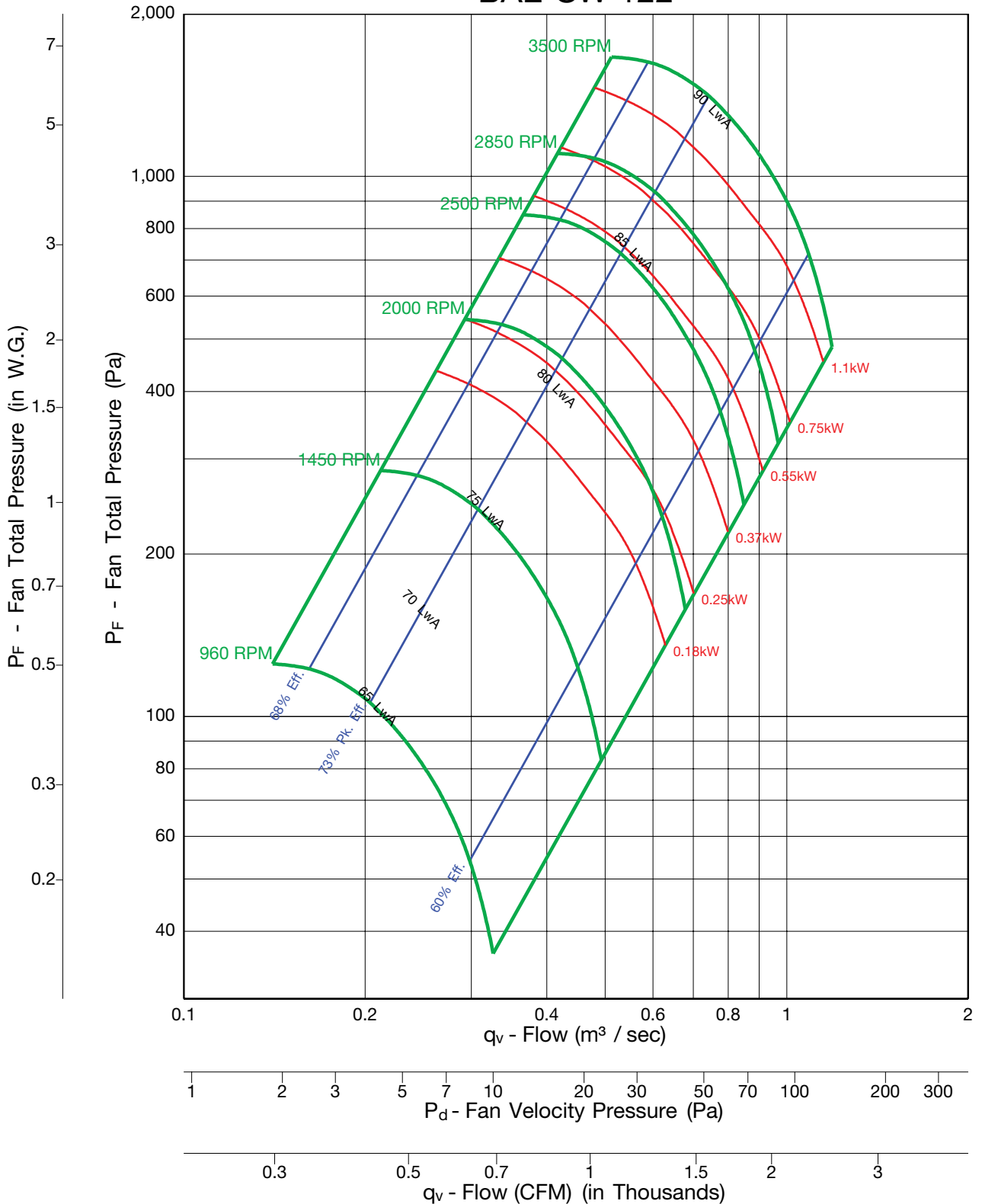

Fan Efficiency Grade = FEG 85



Notes:

1. Performance certified is for Installation Type B & D: Free or ducted inlet, ducted outlet.
2. Power rating (kW) does not include transmission losses.
3. Performance ratings do not include the effects of appurtenances (accessories).
4. The sound power level ratings shown are in decibels, referred to 10 E-12 watts calculated per AMCA Standard 301.
5. Values shown are for inlet LwA sound power levels for Installation Type B: Free inlet, ducted outlet.
6. Ratings do not include the effects of duct end correction.
7. The A-weighted sound ratings shown have been calculated per AMCA Standard 301.

BAE-SW 135

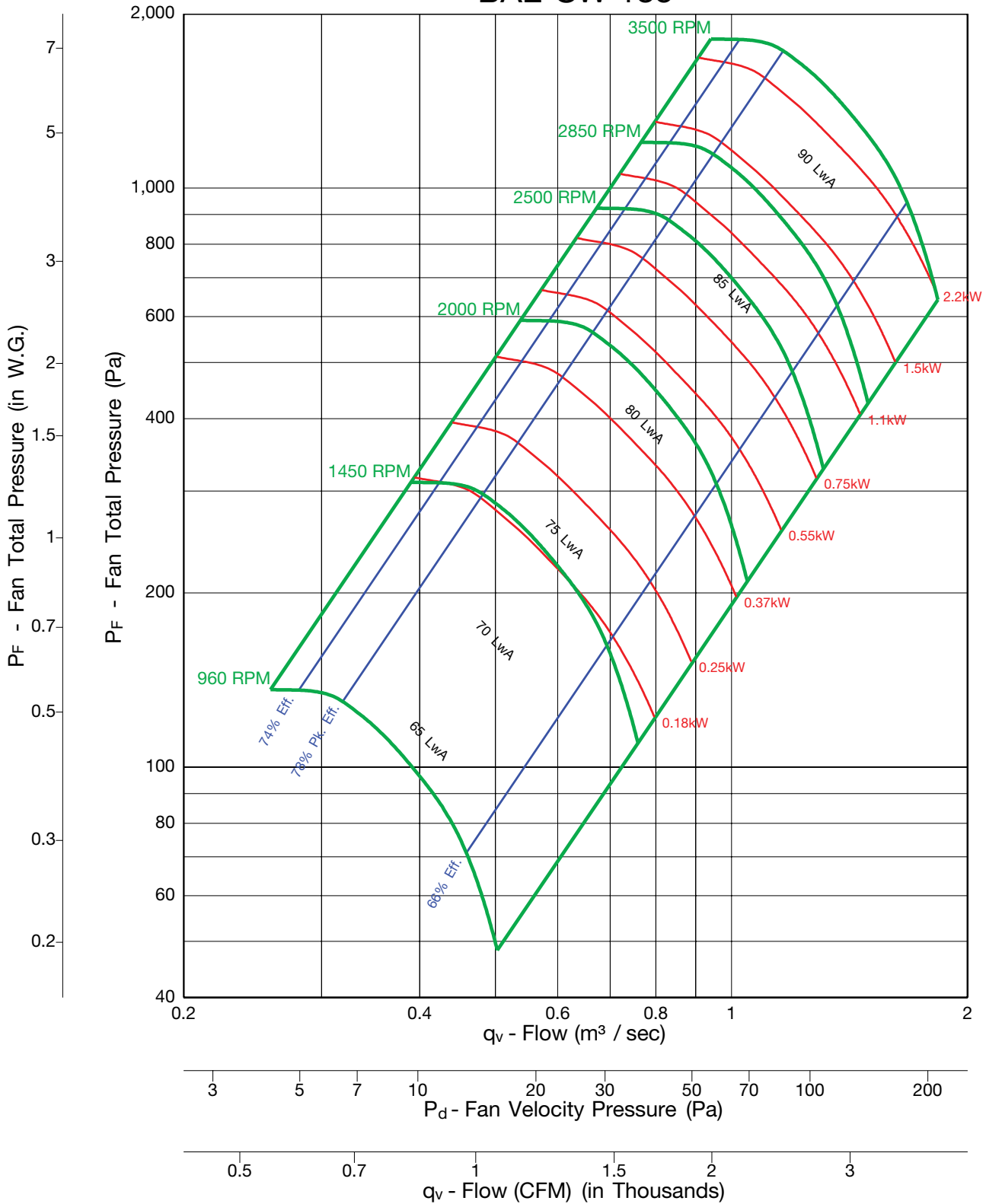

Fan Efficiency Grade = FEG 90



Notes:

1. Performance certified is for Installation Type B & D: Free or ducted inlet, ducted outlet.
2. Power rating (kW) does not include transmission losses.
3. Performance ratings do not include the effects of appurtenances (accessories).
4. The sound power level ratings shown are in decibels, referred to 10 E-12 watts calculated per AMCA Standard 301.
5. Values shown are for inlet LwA sound power levels for Installation Type B: Free inlet, ducted outlet.
6. Ratings do not include the effects of duct end correction.
7. The A-weighted sound ratings shown have been calculated per AMCA Standard 301.

BAE-SW 150

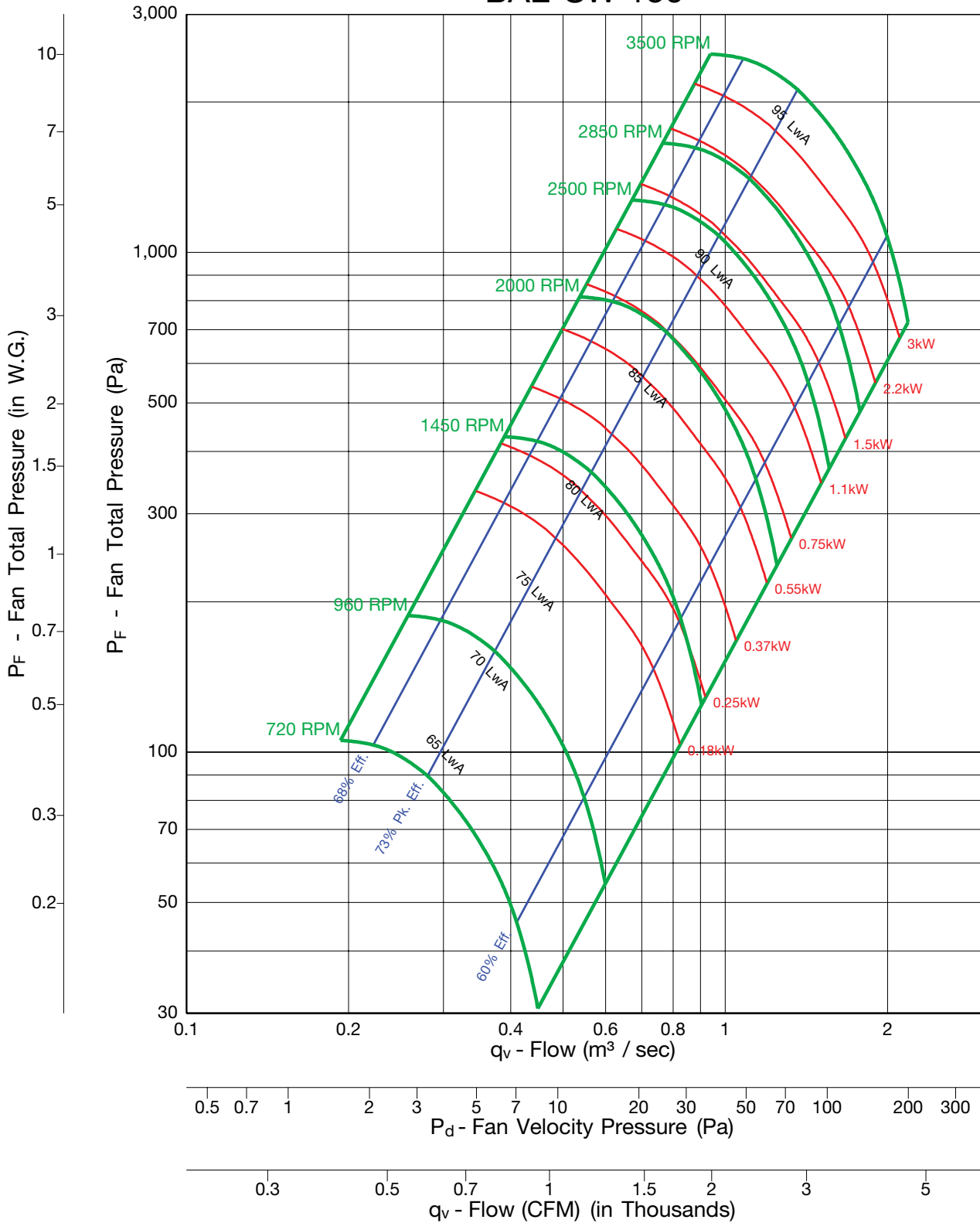

Fan Efficiency Grade = FEG 80



Notes:

1. Performance certified is for Installation Type B & D: Free or ducted inlet, ducted outlet.
2. Power rating (kW) does not include transmission losses.
3. Performance ratings do not include the effects of appurtenances (accessories).
4. The sound power level ratings shown are in decibels, referred to 10 E-12 watts calculated per AMCA Standard 301.
5. Values shown are for inlet LwA sound power levels for Installation Type B: Free inlet, ducted outlet.
6. Ratings do not include the effects of duct end correction.
7. The A-weighted sound ratings shown have been calculated per AMCA Standard 301.

BAE-SW 165

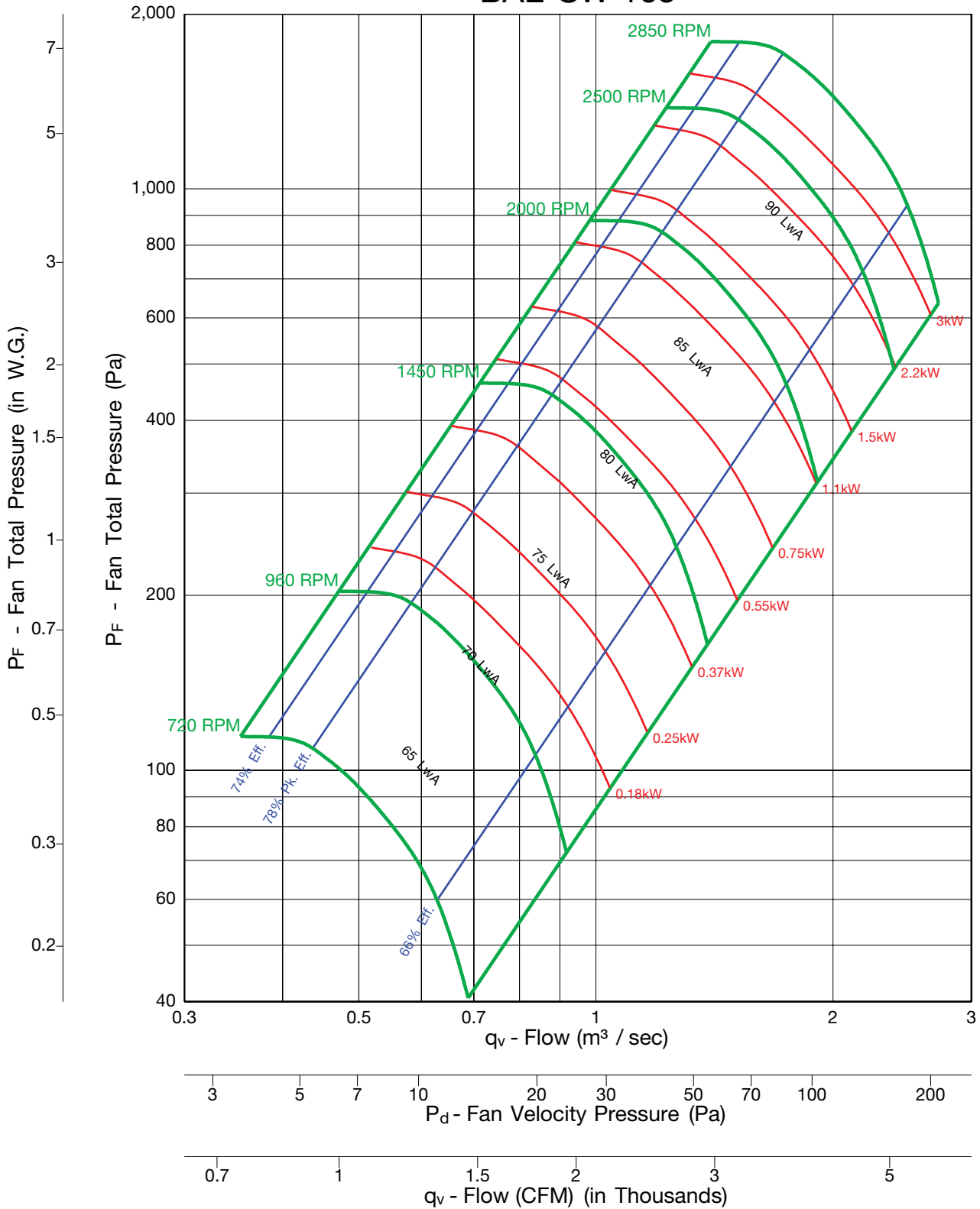

Fan Efficiency Grade = FEG 85



Notes:

1. Performance certified is for Installation Type B & D: Free or ducted inlet, ducted outlet.
2. Power rating (kW) does not include transmission losses.
3. Performance ratings do not include the effects of appurtenances (accessories).
4. The sound power level ratings shown are in decibels, referred to 10 E-12 watts calculated per AMCA Standard 301.
5. Values shown are for inlet LwA sound power levels for Installation Type B: Free inlet, ducted outlet.
6. Ratings do not include the effects of duct end correction.
7. The A-weighted sound ratings shown have been calculated per AMCA Standard 301.

BAE-SW 182

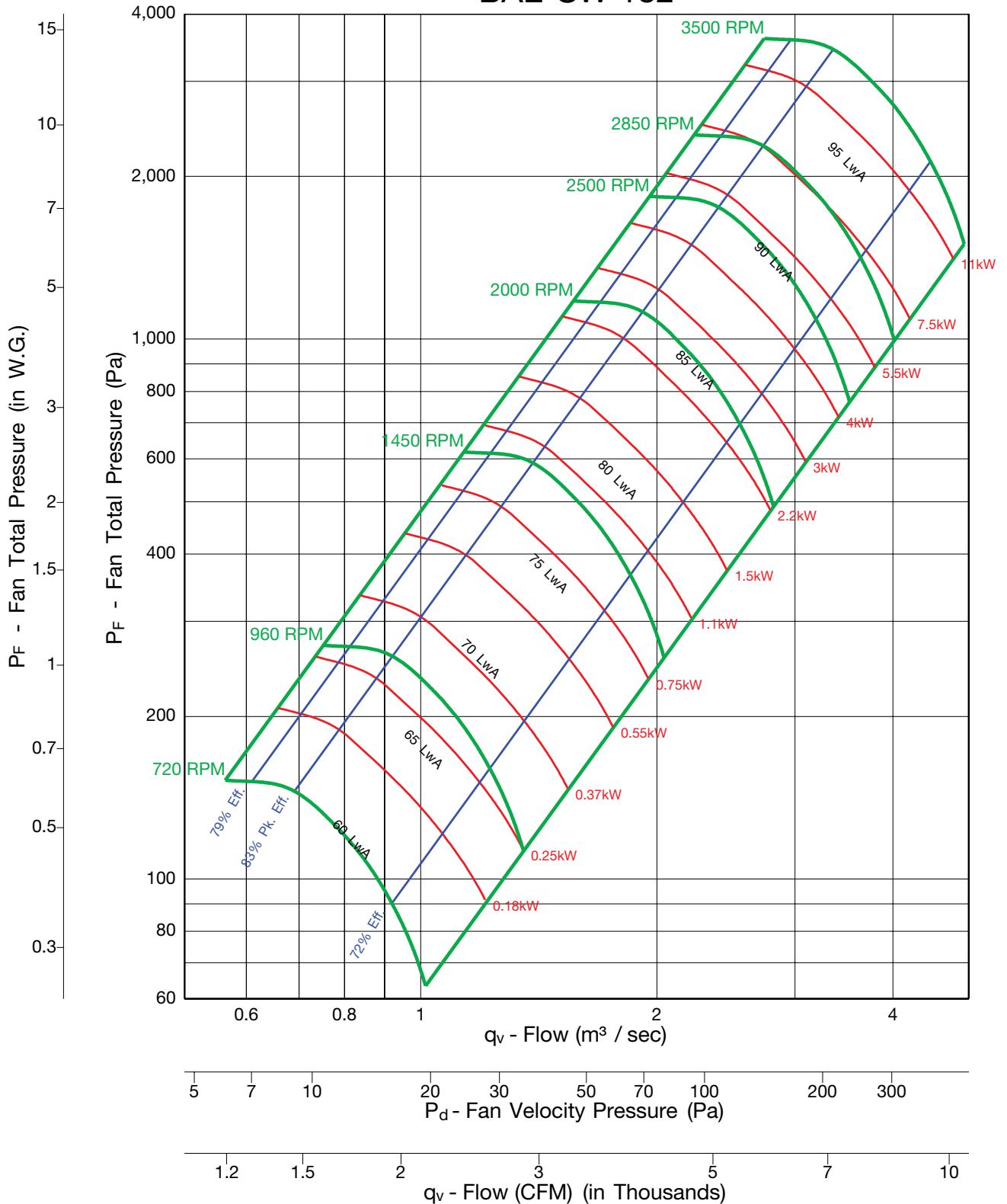

Fan Efficiency Grade = FEG 90



Notes:

1. Performance certified is for Installation Type B & D: Free or ducted inlet, ducted outlet.
2. Power rating (kW) does not include transmission losses.
3. Performance ratings do not include the effects of appurtenances (accessories).
4. The sound power level ratings shown are in decibels, referred to 10 E-12 watts calculated per AMCA Standard 301.
5. Values shown are for inlet LwA sound power levels for Installation Type B: Free inlet, ducted outlet.
6. Ratings do not include the effects of duct end correction.
7. The A-weighted sound ratings shown have been calculated per AMCA Standard 301.

BAE-SW 200

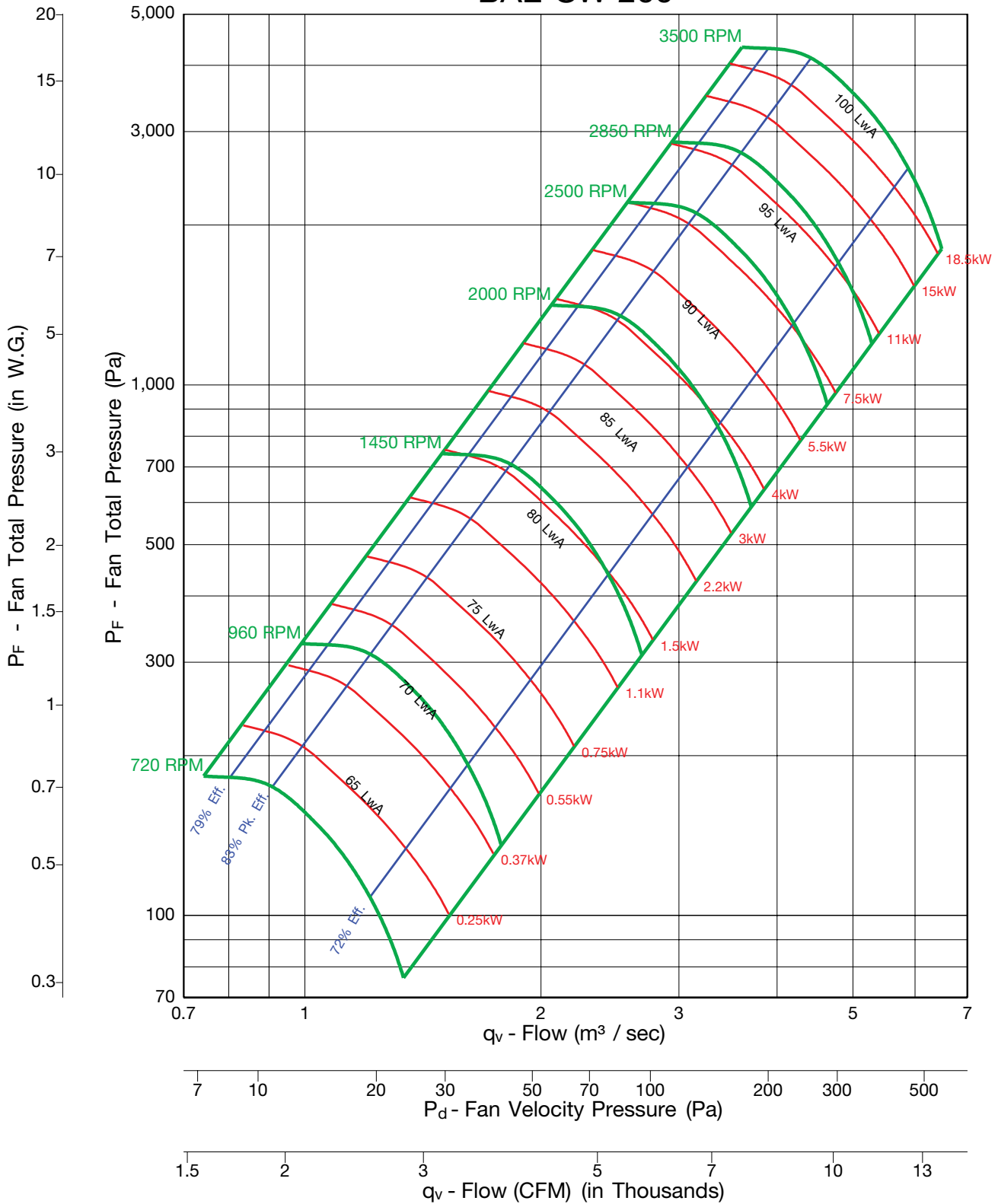

Fan Efficiency Grade = FEG 90



Notes:

1. Performance certified is for Installation Type B & D: Free or ducted inlet, ducted outlet.
2. Power rating (kW) does not include transmission losses.
3. Performance ratings do not include the effects of appurtenances (accessories).
4. The sound power level ratings shown are in decibels, referred to 10 E-12 watts calculated per AMCA Standard 301.
5. Values shown are for inlet LwA sound power levels for Installation Type B: Free inlet, ducted outlet.
6. Ratings do not include the effects of duct end correction.
7. The A-weighted sound ratings shown have been calculated per AMCA Standard 301.

BAE-SW 222

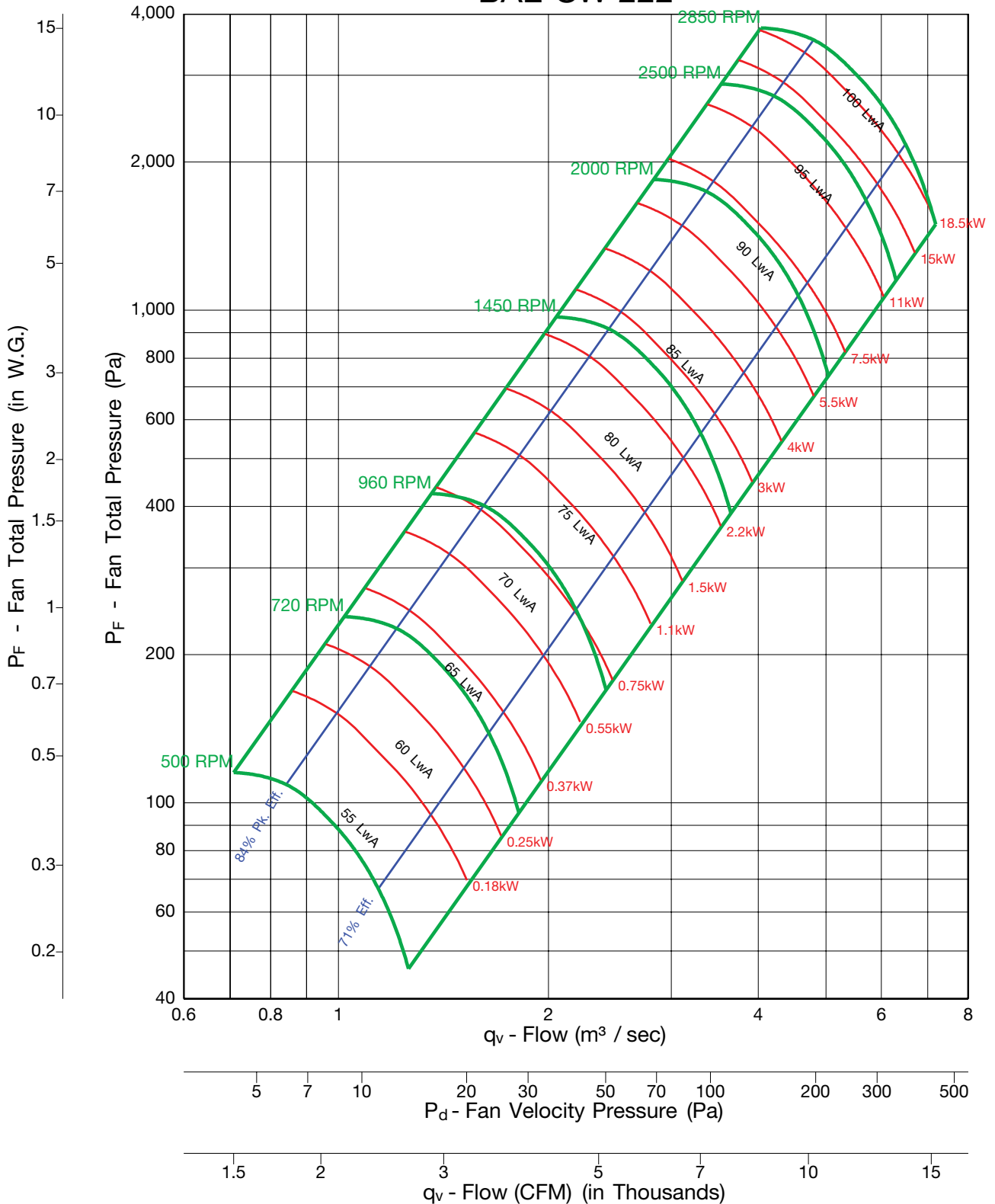

Fan Efficiency Grade = FEG 90



Notes:

1. Performance certified is for Installation Type B & D: Free or ducted inlet, ducted outlet.
2. Power rating (kW) does not include transmission losses.
3. Performance ratings do not include the effects of appurtenances (accessories).
4. The sound power level ratings shown are in decibels, referred to 10 E-12 watts calculated per AMCA Standard 301.
5. Values shown are for inlet LwA sound power levels for Installation Type B: Free inlet, ducted outlet.
6. Ratings do not include the effects of duct end correction.
7. The A-weighted sound ratings shown have been calculated per AMCA Standard 301.

BAE-SW 245

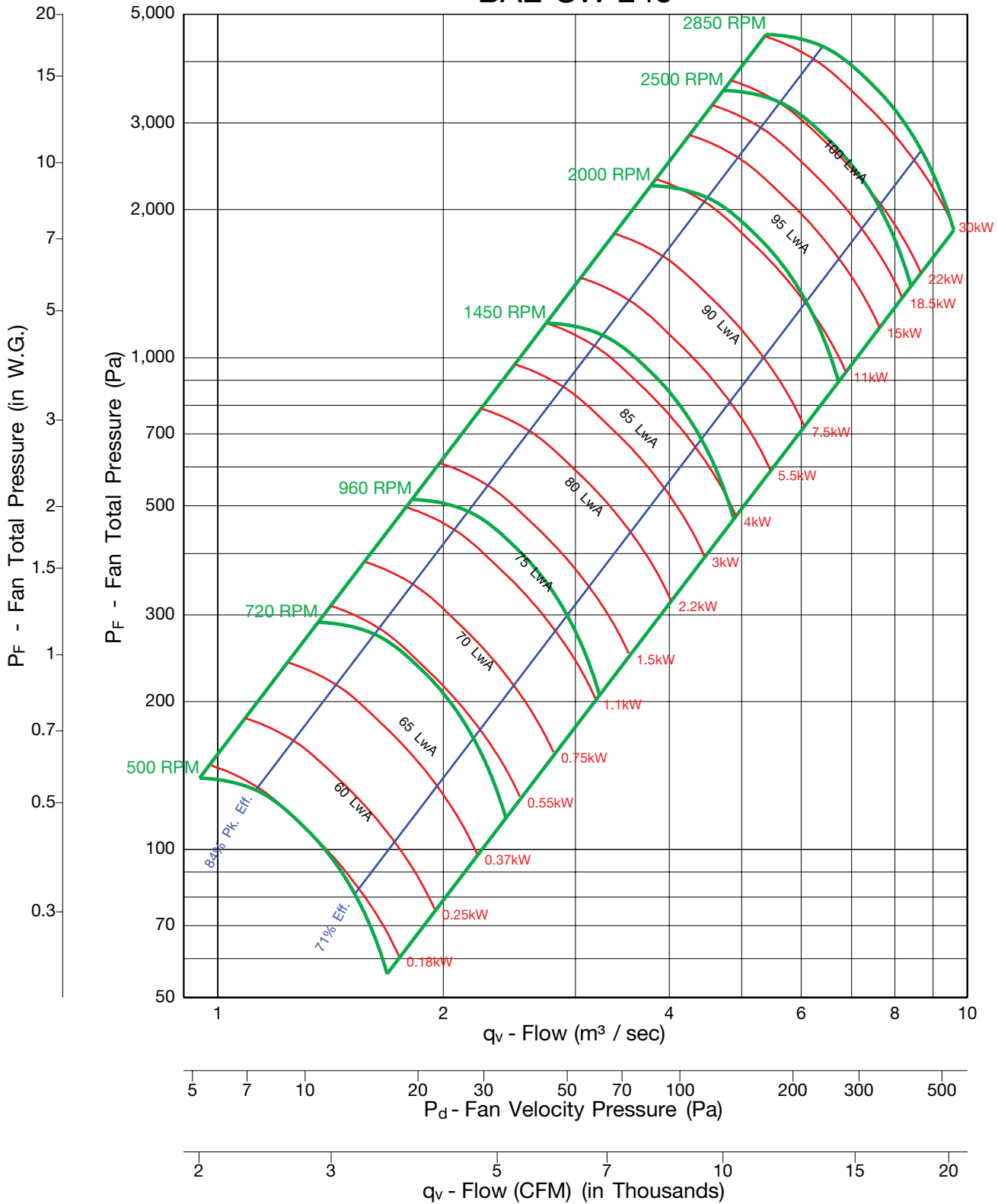

Fan Efficiency Grade = FEG 90



Notes:

1. Performance certified is for Installation Type B & D: Free or ducted inlet, ducted outlet.
2. Power rating (kW) does not include transmission losses.
3. Performance ratings do not include the effects of appurtenances (accessories).
4. The sound power level ratings shown are in decibels, referred to 10 E-12 watts calculated per AMCA Standard 301.
5. Values shown are for inlet LwA sound power levels for Installation Type B: Free inlet, ducted outlet.
6. Ratings do not include the effects of duct end correction.
7. The A-weighted sound ratings shown have been calculated per AMCA Standard 301.

BAE-SW 270

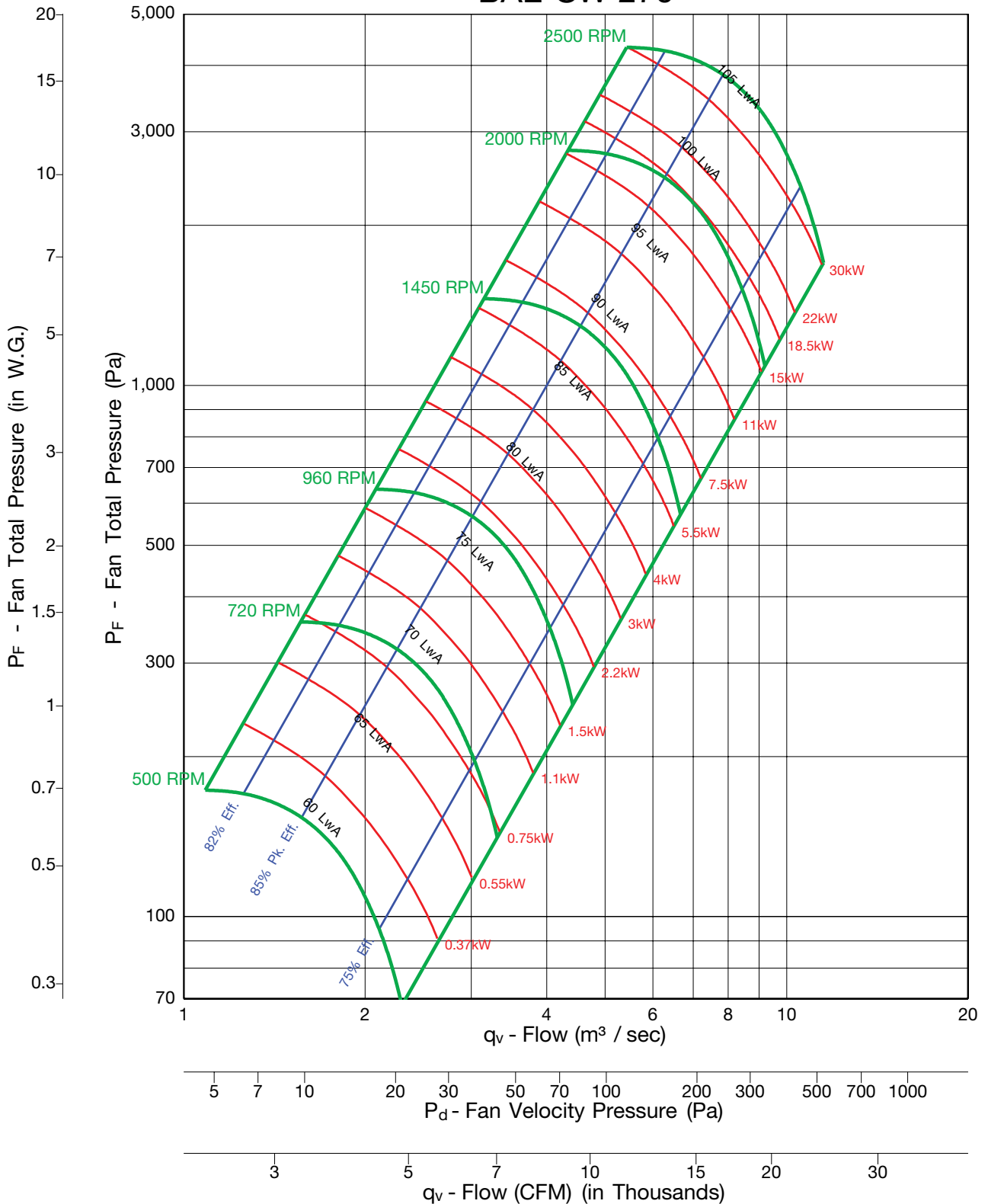

Fan Efficiency Grade = FEG 90



Notes:

1. Performance certified is for Installation Type B & D: Free or ducted inlet, ducted outlet.
2. Power rating (kW) does not include transmission losses.
3. Performance ratings do not include the effects of appurtenances (accessories).
4. The sound power level ratings shown are in decibels, referred to 10 E-12 watts calculated per AMCA Standard 301.
5. Values shown are for inlet LwA sound power levels for Installation Type B: Free inlet, ducted outlet.
6. Ratings do not include the effects of duct end correction.
7. The A-weighted sound ratings shown have been calculated per AMCA Standard 301.

BAE-SW 300

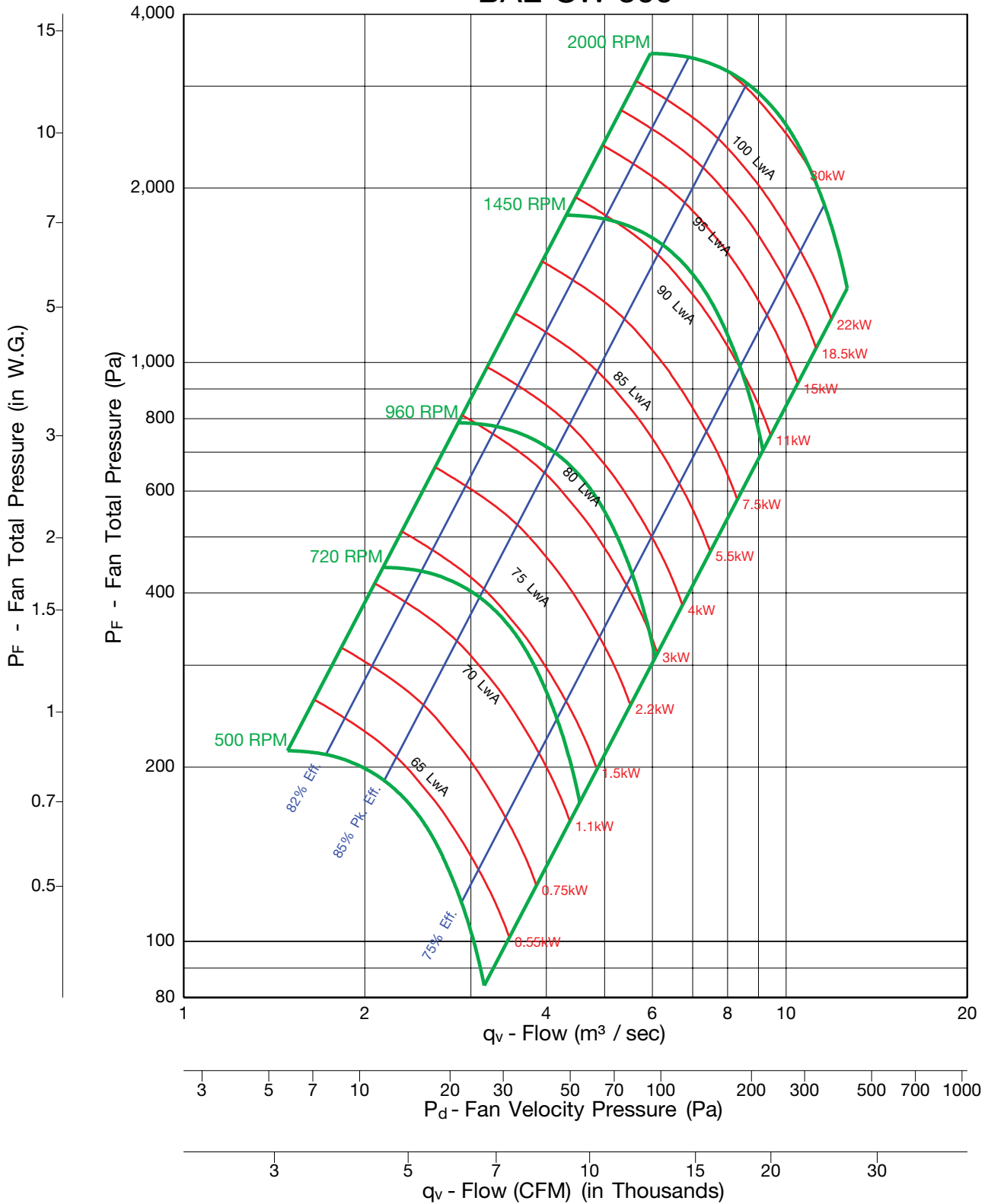

Fan Efficiency Grade = FEG 90



Notes:

1. Performance certified is for Installation Type B & D: Free or ducted inlet, ducted outlet.
2. Power rating (kW) does not include transmission losses.
3. Performance ratings do not include the effects of appurtenances (accessories).
4. The sound power level ratings shown are in decibels, referred to 10 E-12 watts calculated per AMCA Standard 301.
5. Values shown are for inlet LwA sound power levels for Installation Type B: Free inlet, ducted outlet.
6. Ratings do not include the effects of duct end correction.
7. The A-weighted sound ratings shown have been calculated per AMCA Standard 301.

BAE-SW 330

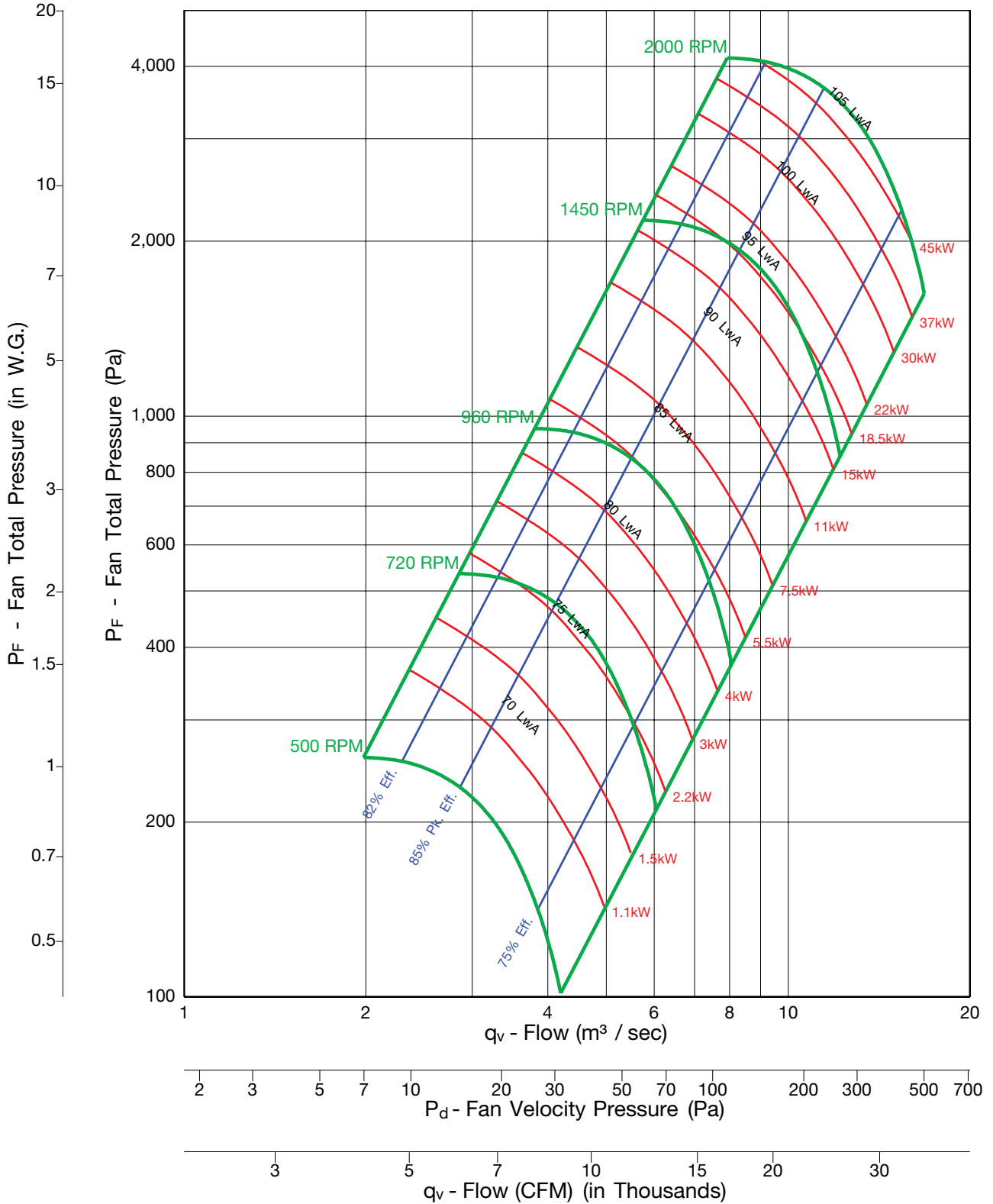

Fan Efficiency Grade = FEG 90



Notes:

1. Performance certified is for Installation Type B & D: Free or ducted inlet, ducted outlet.
2. Power rating (kW) does not include transmission losses.
3. Performance ratings do not include the effects of appurtenances (accessories).
4. The sound power level ratings shown are in decibels, referred to 10 E-12 watts calculated per AMCA Standard 301.
5. Values shown are for inlet LwA sound power levels for Installation Type B: Free inlet, ducted outlet.
6. Ratings do not include the effects of duct end correction.
7. The A-weighted sound ratings shown have been calculated per AMCA Standard 301.

BAE-SW 365

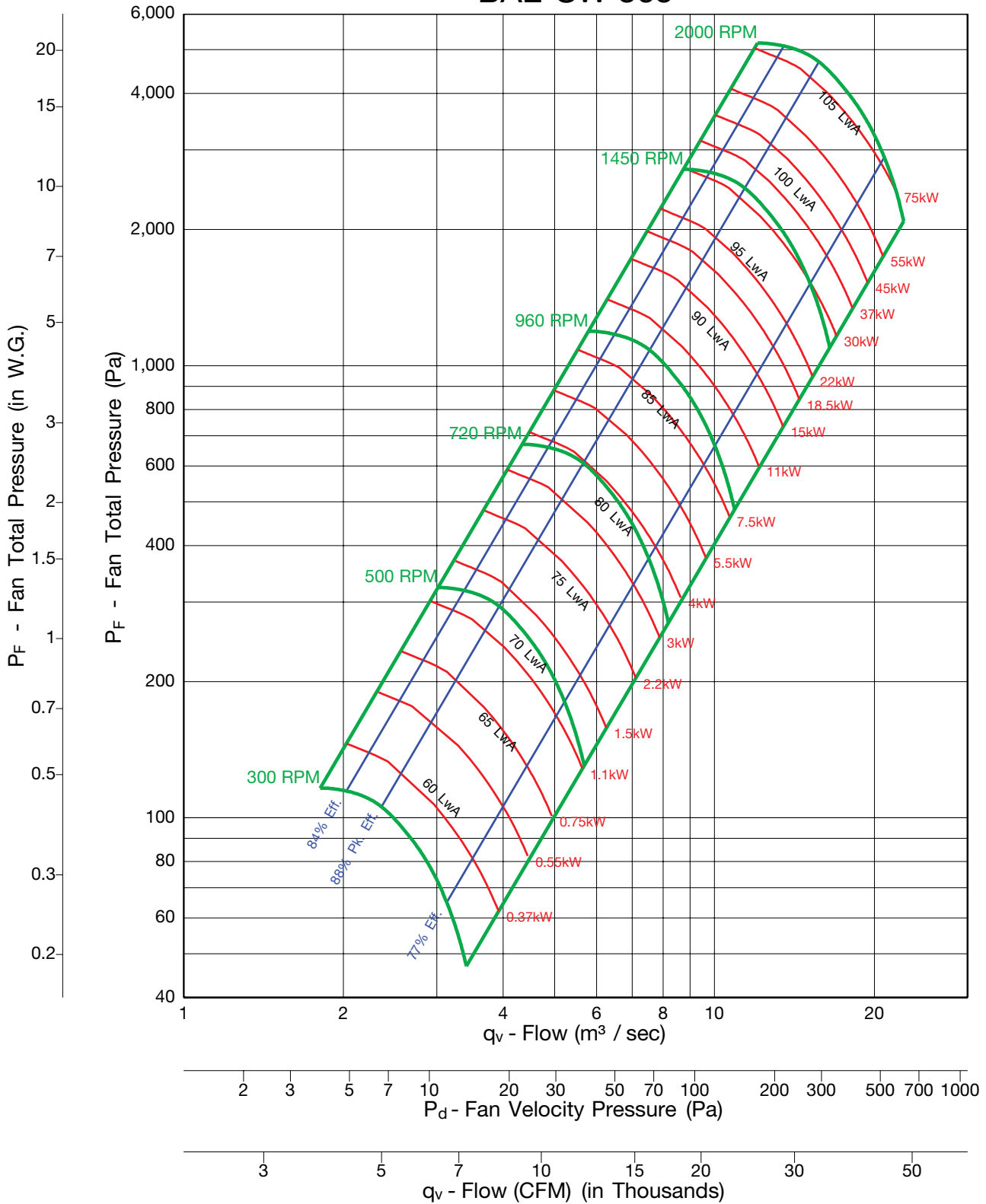

Fan Efficiency Grade = FEG 90



Notes:

1. Performance certified is for Installation Type B & D: Free or ducted inlet, ducted outlet.
2. Power rating (kW) does not include transmission losses.
3. Performance ratings do not include the effects of appurtenances (accessories).
4. The sound power level ratings shown are in decibels, referred to 10 E-12 watts calculated per AMCA Standard 301.
5. Values shown are for inlet LwA sound power levels for Installation Type B: Free inlet, ducted outlet.
6. Ratings do not include the effects of duct end correction.
7. The A-weighted sound ratings shown have been calculated per AMCA Standard 301.

BAE-SW 402

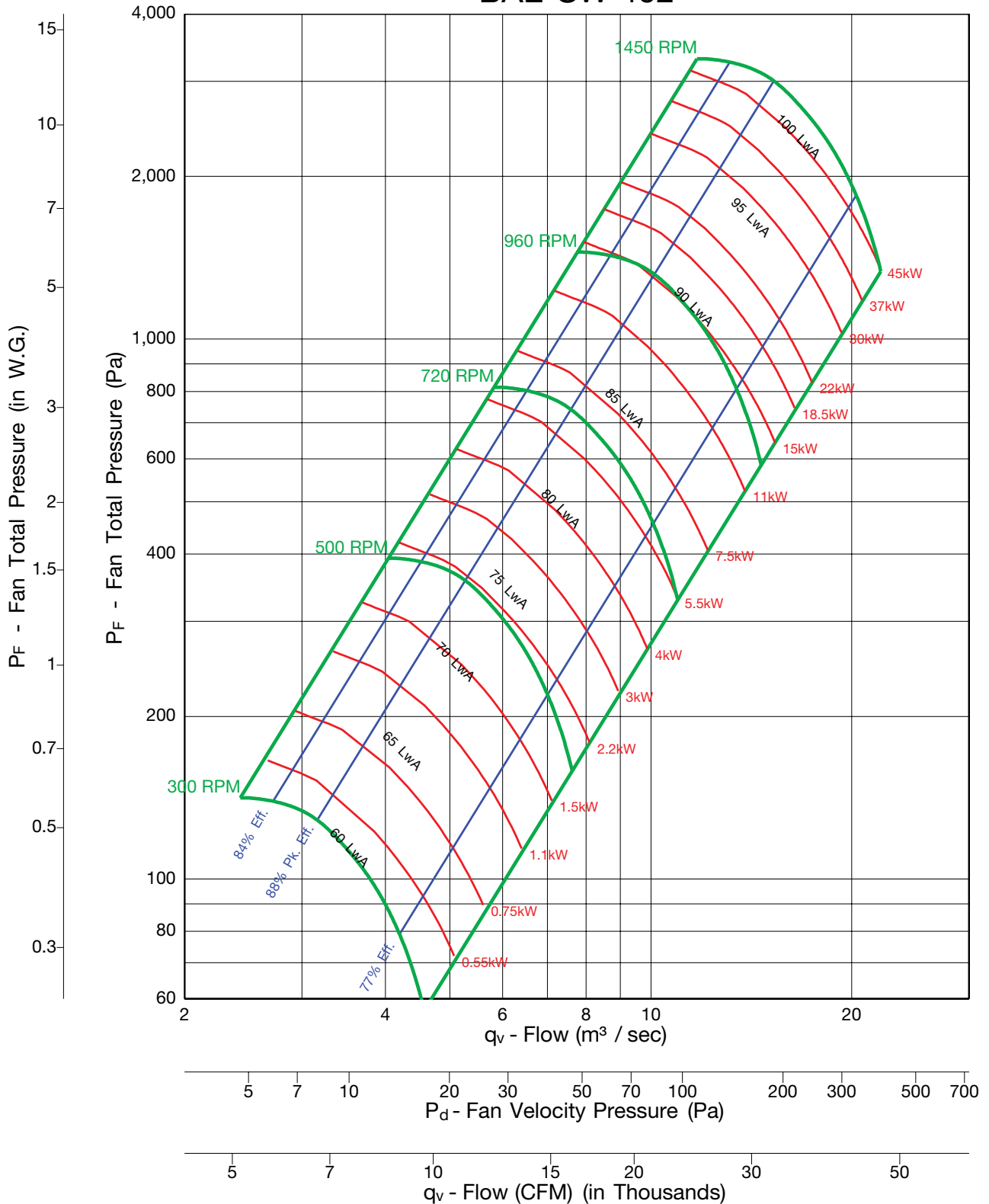

Fan Efficiency Grade = FEG 90



Notes:

1. Performance certified is for Installation Type B & D: Free or ducted inlet, ducted outlet.
2. Power rating (kW) does not include transmission losses.
3. Performance ratings do not include the effects of appurtenances (accessories).
4. The sound power level ratings shown are in decibels, referred to 10 E-12 watts calculated per AMCA Standard 301.
5. Values shown are for inlet LwA sound power levels for Installation Type B: Free inlet, ducted outlet.
6. Ratings do not include the effects of duct end correction.
7. The A-weighted sound ratings shown have been calculated per AMCA Standard 301.

BAE-SW 445

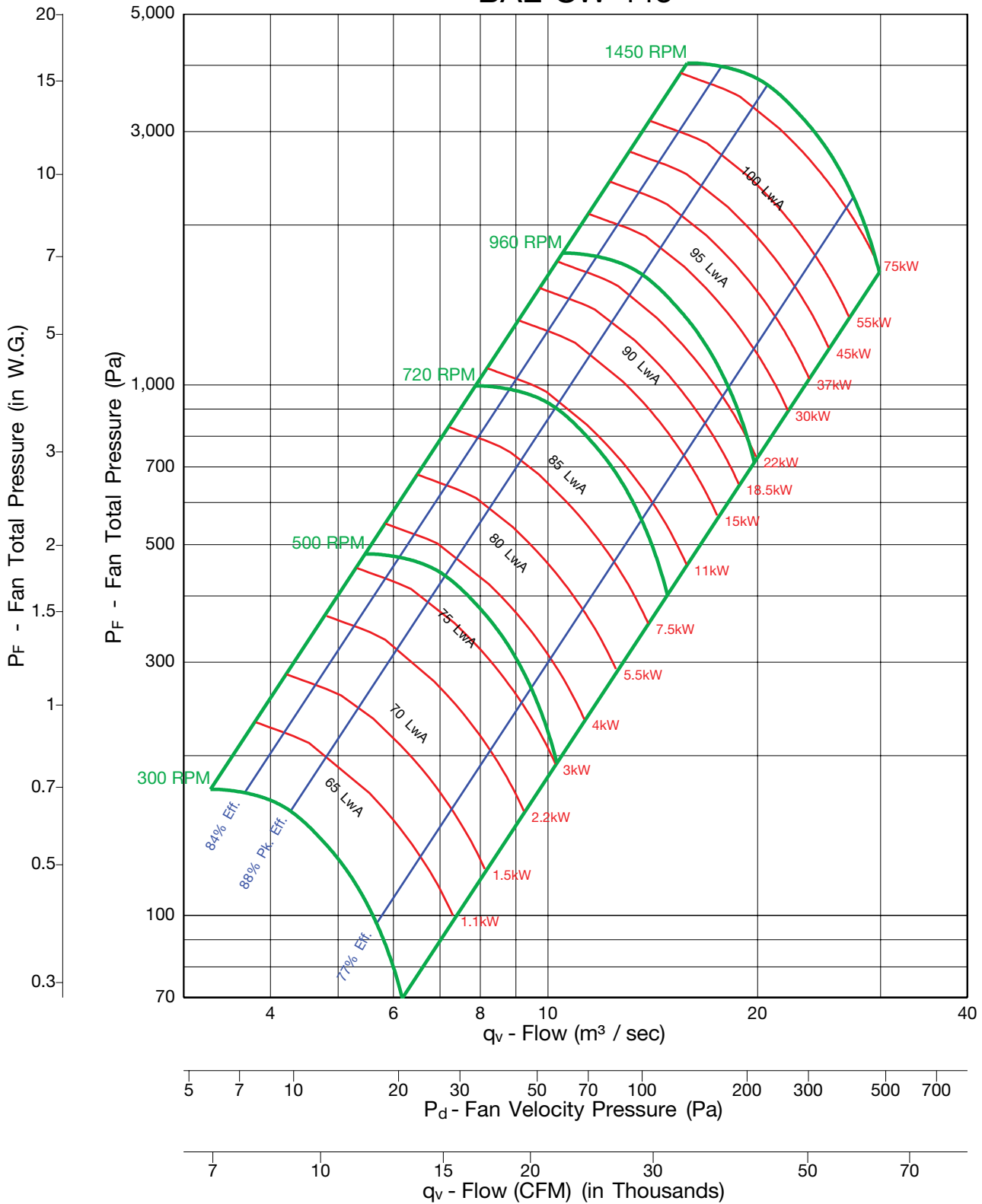

Fan Efficiency Grade = FEG 90



Notes:

1. Performance certified is for Installation Type B & D: Free or ducted inlet, ducted outlet.
2. Power rating (kW) does not include transmission losses.
3. Performance ratings do not include the effects of appurtenances (accessories).
4. The sound power level ratings shown are in decibels, referred to 10 E-12 watts calculated per AMCA Standard 301.
5. Values shown are for inlet LwA sound power levels for Installation Type B: Free inlet, ducted outlet.
6. Ratings do not include the effects of duct end correction.
7. The A-weighted sound ratings shown have been calculated per AMCA Standard 301.

BAE-SW 490

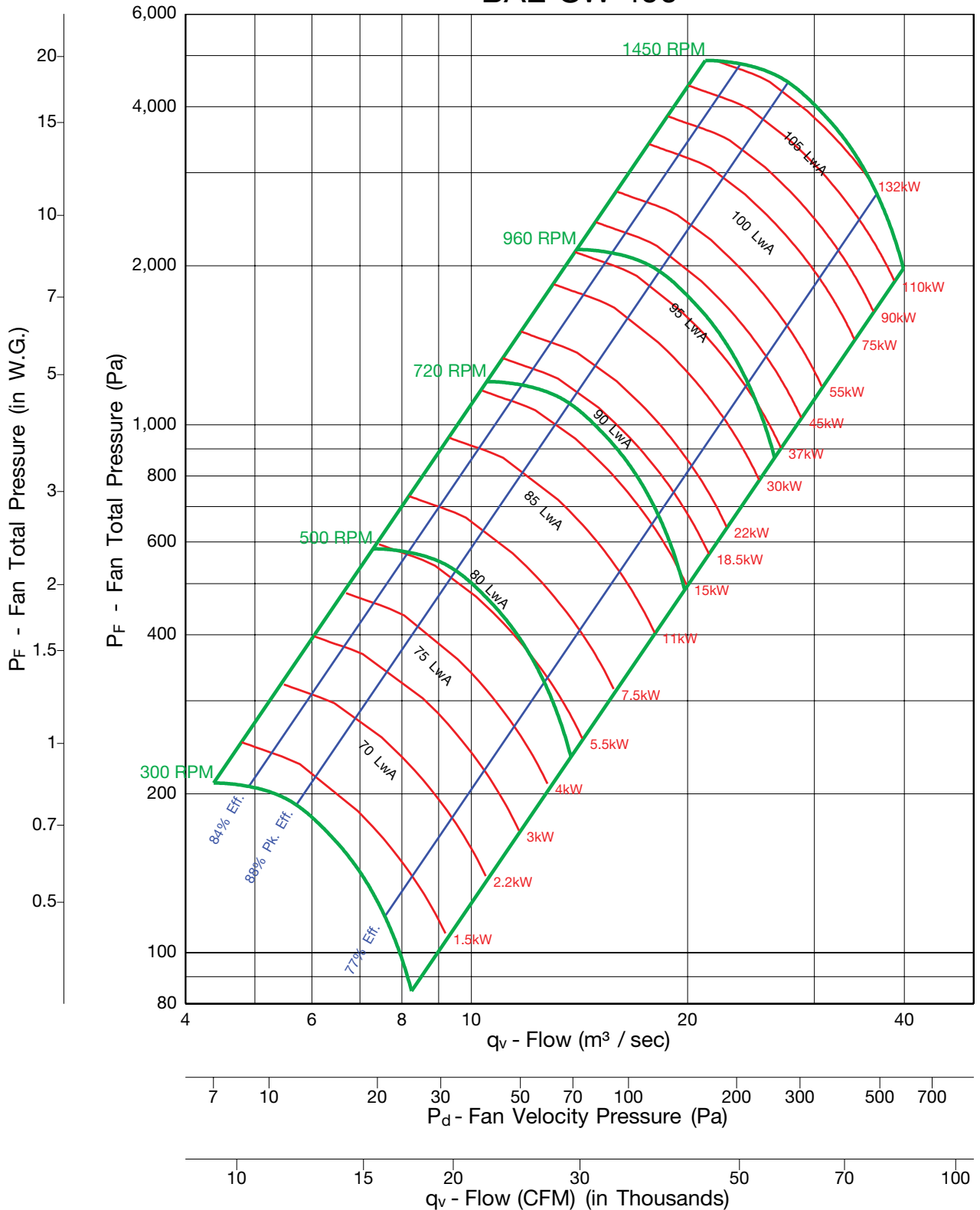

Fan Efficiency Grade = FEG 90



Notes:

1. Performance certified is for Installation Type B & D: Free or ducted inlet, ducted outlet.
2. Power rating (kW) does not include transmission losses.
3. Performance ratings do not include the effects of appurtenances (accessories).
4. The sound power level ratings shown are in decibels, referred to 10 E-12 watts calculated per AMCA Standard 301.
5. Values shown are for inlet LwA sound power levels for Installation Type B: Free inlet, ducted outlet.
6. Ratings do not include the effects of duct end correction.
7. The A-weighted sound ratings shown have been calculated per AMCA Standard 301.

BAE-SW 542

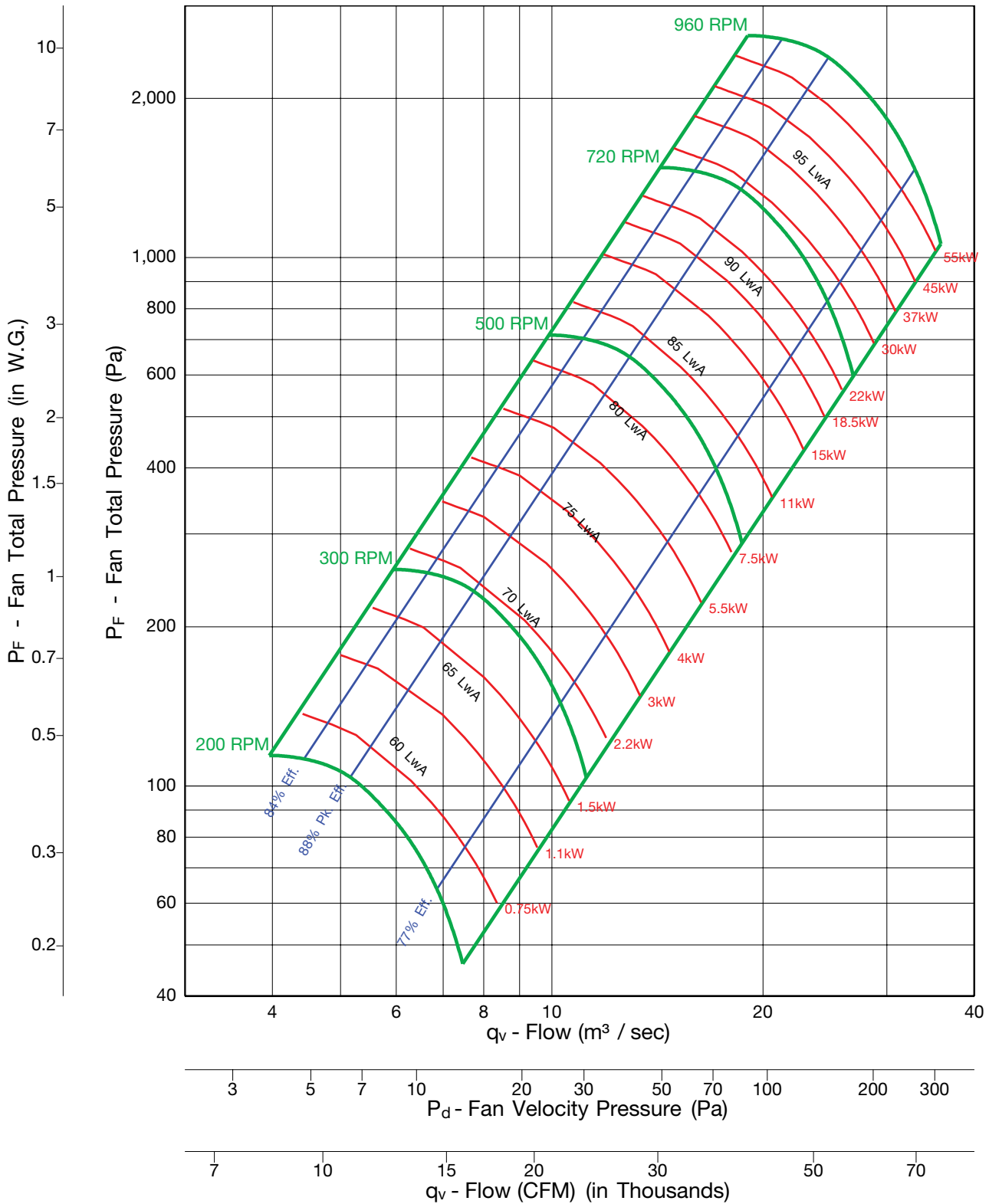

Fan Efficiency Grade = FEG 90



Notes:

1. Performance certified is for Installation Type B & D: Free or ducted inlet, ducted outlet.
2. Power rating (kW) does not include transmission losses.
3. Performance ratings do not include the effects of appurtenances (accessories).
4. The sound power level ratings shown are in decibels, referred to 10 E-12 watts calculated per AMCA Standard 301.
5. Values shown are for inlet LwA sound power levels for Installation Type B: Free inlet, ducted outlet.
6. Ratings do not include the effects of duct end correction.
7. The A-weighted sound ratings shown have been calculated per AMCA Standard 301.

BAE-SW 600

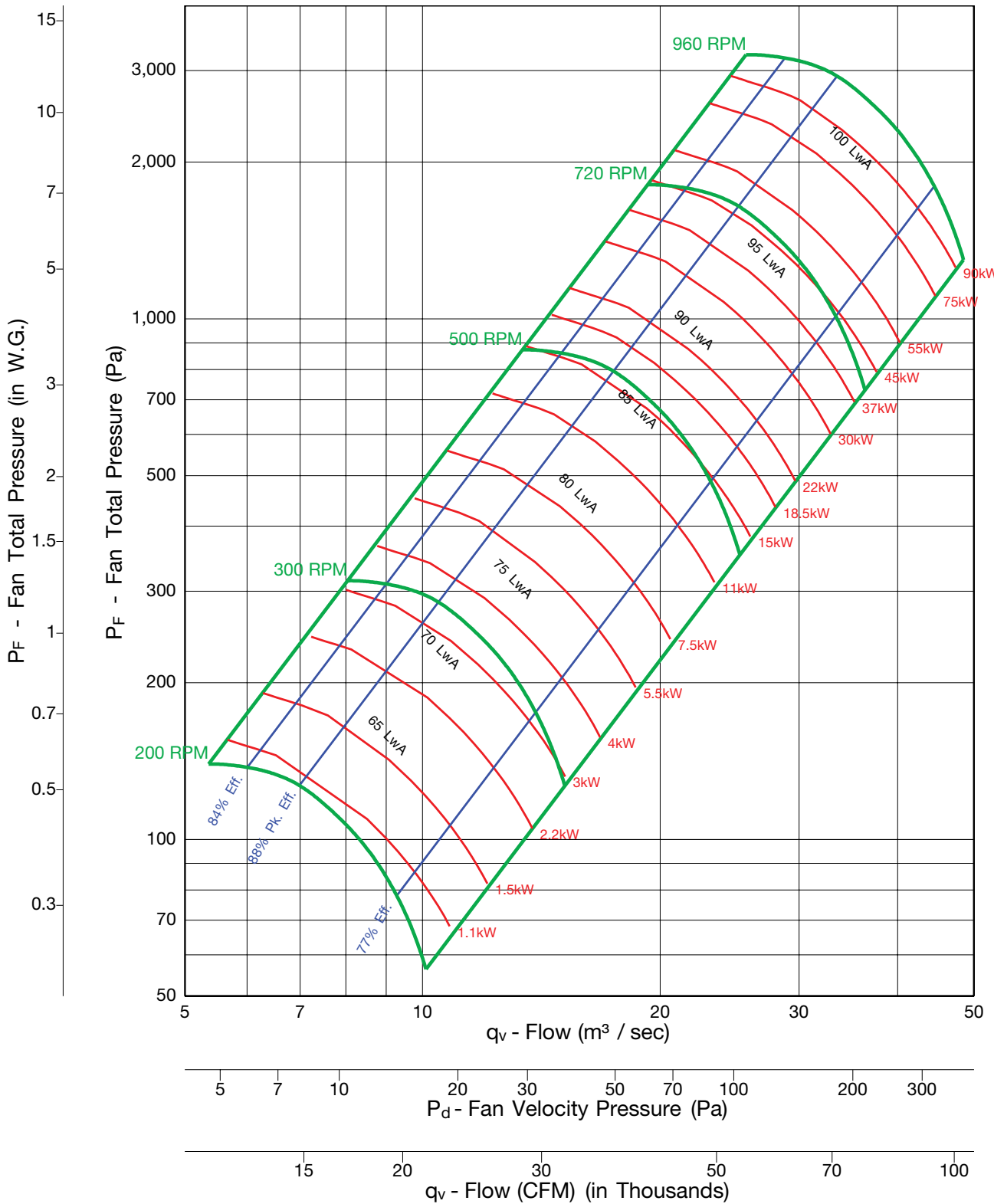

Fan Efficiency Grade = FEG 90



Notes:

1. Performance certified is for Installation Type B & D: Free or ducted inlet, ducted outlet.
2. Power rating (kW) does not include transmission losses.
3. Performance ratings do not include the effects of appurtenances (accessories).
4. The sound power level ratings shown are in decibels, referred to 10 E-12 watts calculated per AMCA Standard 301.
5. Values shown are for inlet LwA sound power levels for Installation Type B: Free inlet, ducted outlet.
6. Ratings do not include the effects of duct end correction.
7. The A-weighted sound ratings shown have been calculated per AMCA Standard 301.

BAE-SW 660

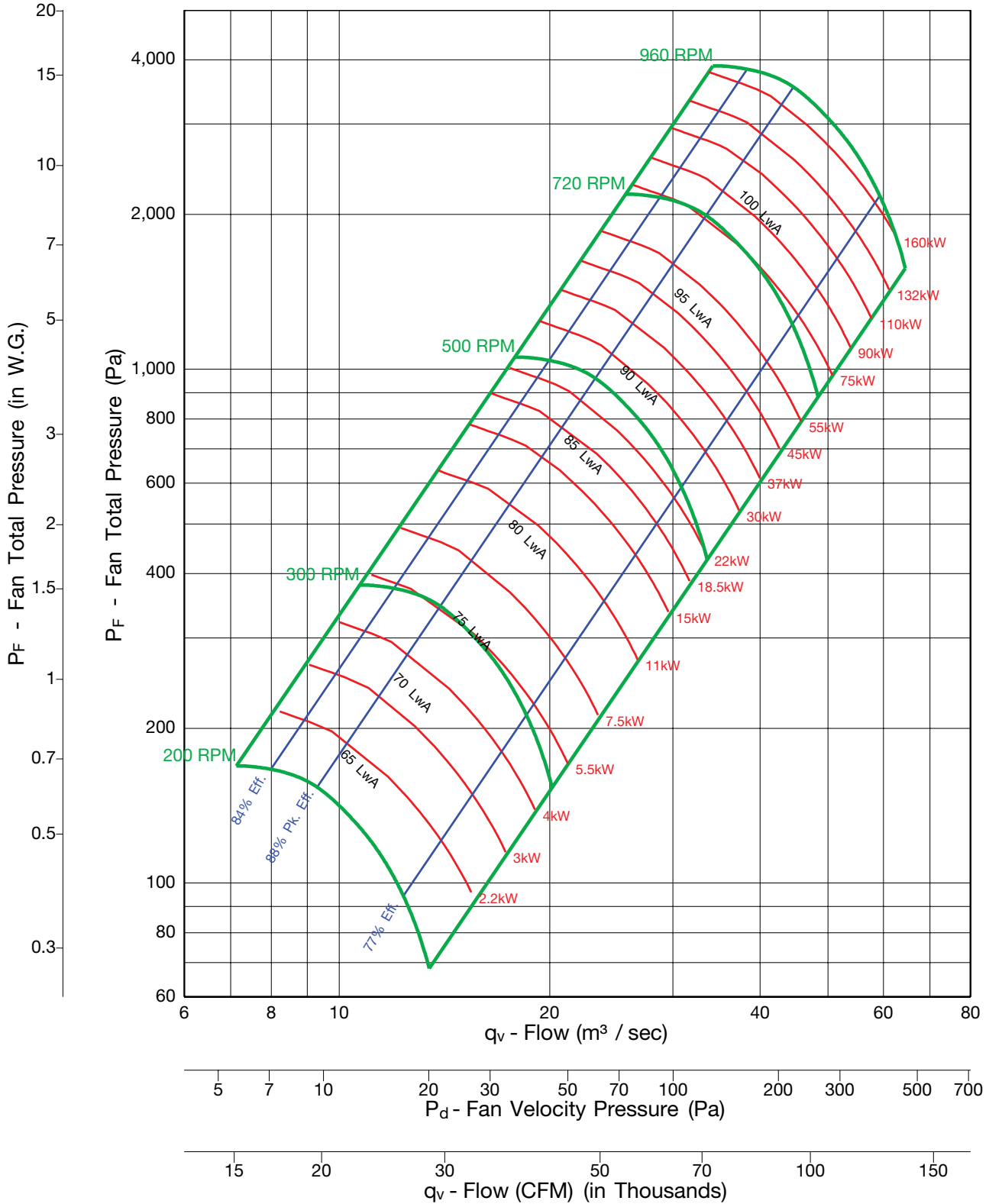

Fan Efficiency Grade = FEG 90



Notes:

1. Performance certified is for Installation Type B & D: Free or ducted inlet, ducted outlet.
2. Power rating (kW) does not include transmission losses.
3. Performance ratings do not include the effects of appurtenances (accessories).
4. The sound power level ratings shown are in decibels, referred to 10 E-12 watts calculated per AMCA Standard 301.
5. Values shown are for inlet LwA sound power levels for Installation Type B: Free inlet, ducted outlet.
6. Ratings do not include the effects of duct end correction.
7. The A-weighted sound ratings shown have been calculated per AMCA Standard 301.

BAE-SW 730

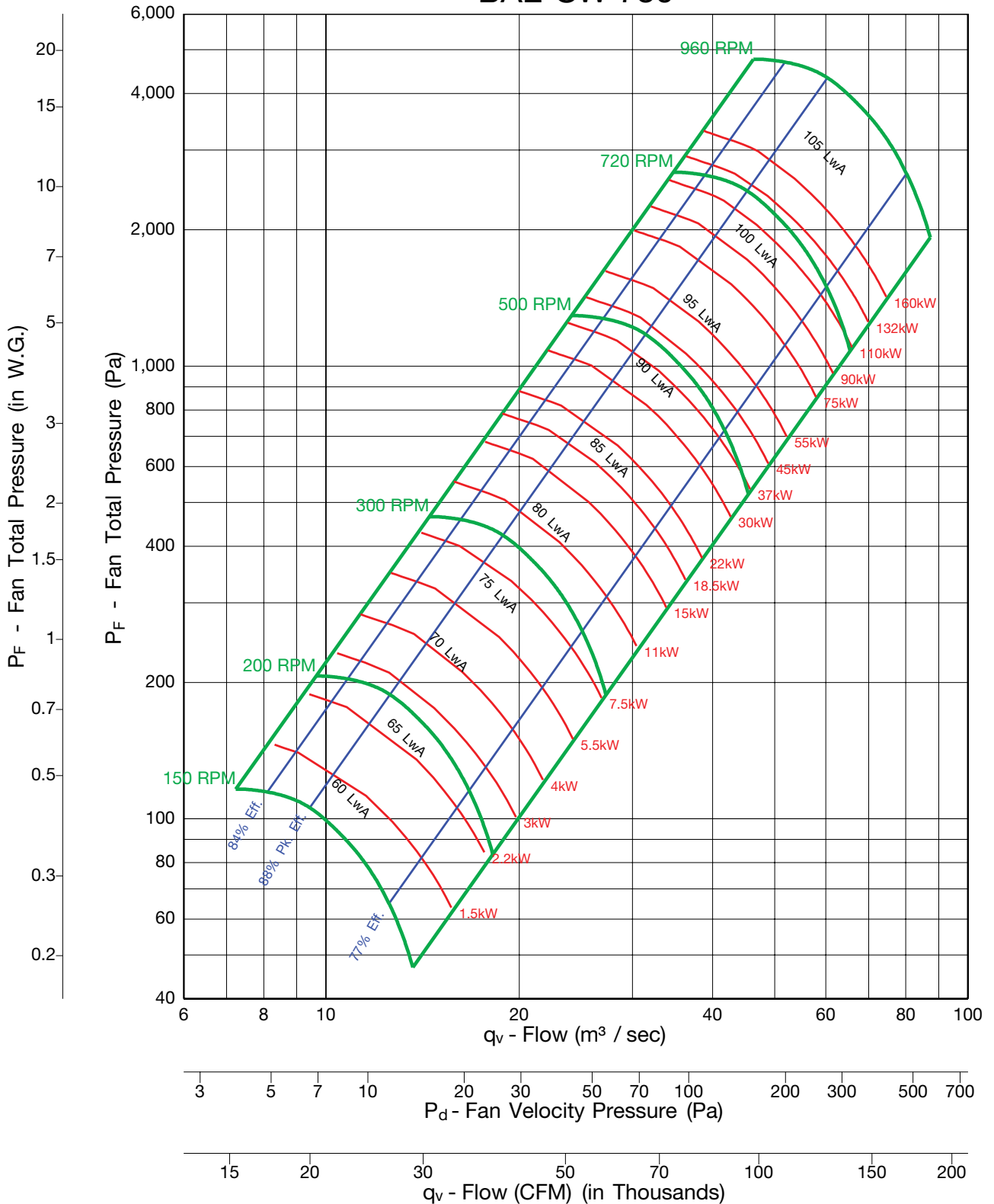

Fan Efficiency Grade = FEG 90



Notes:

1. Performance certified is for Installation Type B & D: Free or ducted inlet, ducted outlet.
2. Power rating (kW) does not include transmission losses.
3. Performance ratings do not include the effects of appurtenances (accessories).
4. The sound power level ratings shown are in decibels, referred to 10 E-12 watts calculated per AMCA Standard 301.
5. Values shown are for inlet LwA sound power levels for Installation Type B: Free inlet, ducted outlet.
6. Ratings do not include the effects of duct end correction.
7. The A-weighted sound ratings shown have been calculated per AMCA Standard 301.

BAE-SW 807

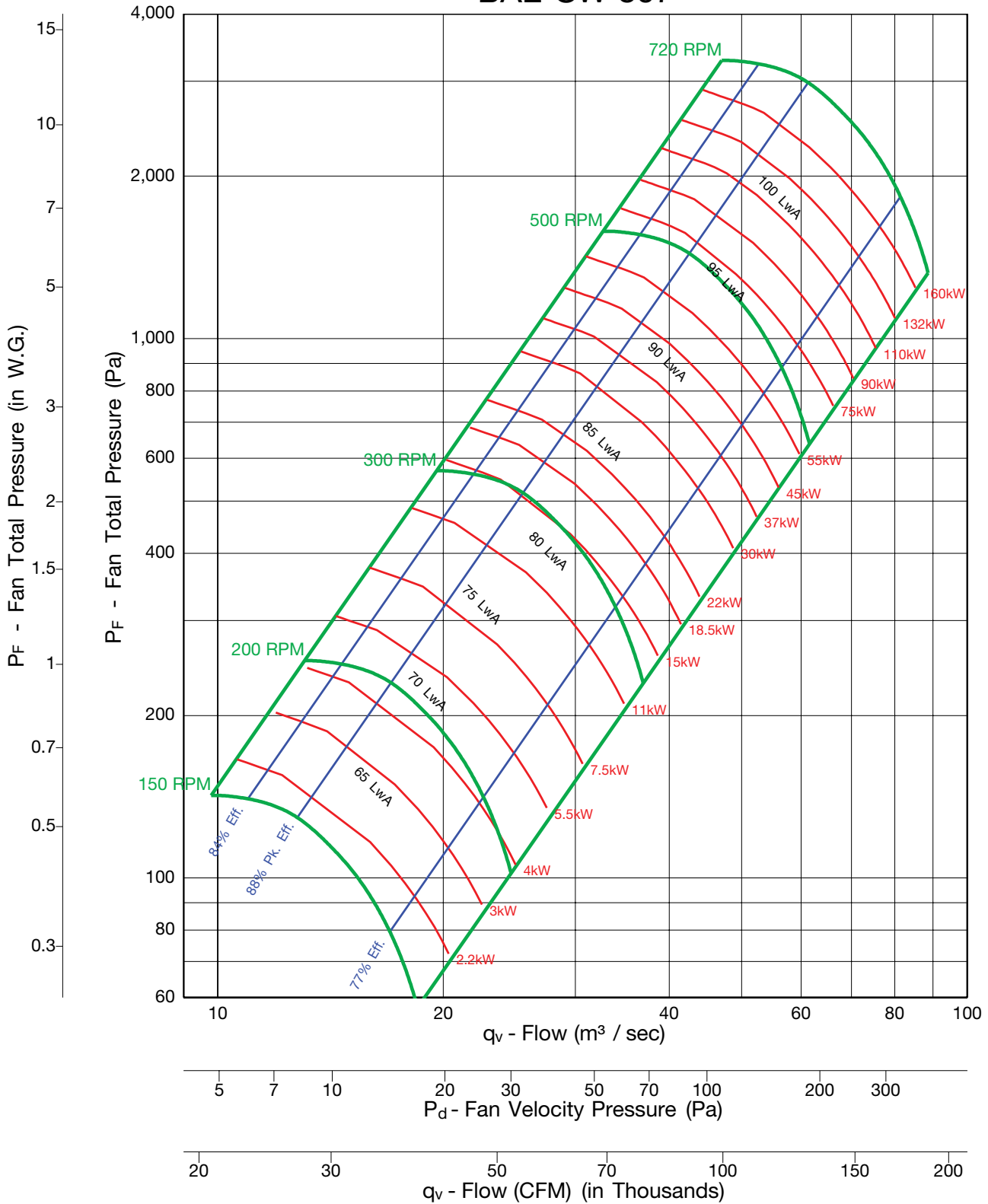

Fan Efficiency Grade = FEG 90



Notes:

1. Performance certified is for Installation Type B & D: Free or ducted inlet, ducted outlet.
2. Power rating (kW) does not include transmission losses.
3. Performance ratings do not include the effects of appurtenances (accessories).
4. The sound power level ratings shown are in decibels, referred to 10 E-12 watts calculated per AMCA Standard 301.
5. Values shown are for inlet LwA sound power levels for Installation Type B: Free inlet, ducted outlet.
6. Ratings do not include the effects of duct end correction.
7. The A-weighted sound ratings shown have been calculated per AMCA Standard 301.

BAE-SW 890

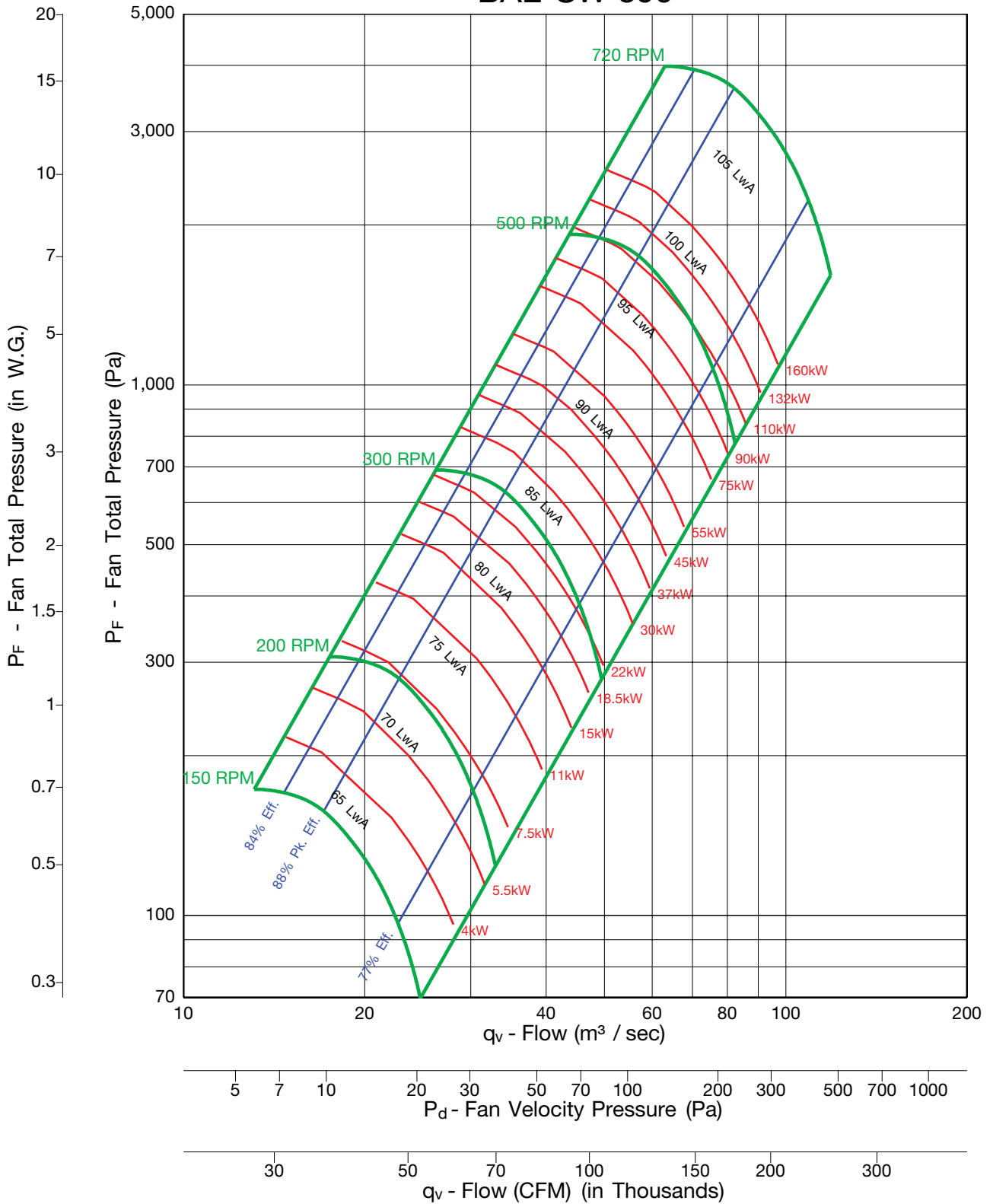

Fan Efficiency Grade = FEG 90



Notes:

1. Performance certified is for Installation Type B & D: Free or ducted inlet, ducted outlet.
2. Power rating (kW) does not include transmission losses.
3. Performance ratings do not include the effects of appurtenances (accessories).
4. The sound power level ratings shown are in decibels, referred to 10 E-12 watts calculated per AMCA Standard 301.
5. Values shown are for inlet LwIA sound power levels for Installation Type B: Free inlet, ducted outlet.
6. Ratings do not include the effects of duct end correction.
7. The A-weighted sound ratings shown have been calculated per AMCA Standard 301.

BAE-SW 982

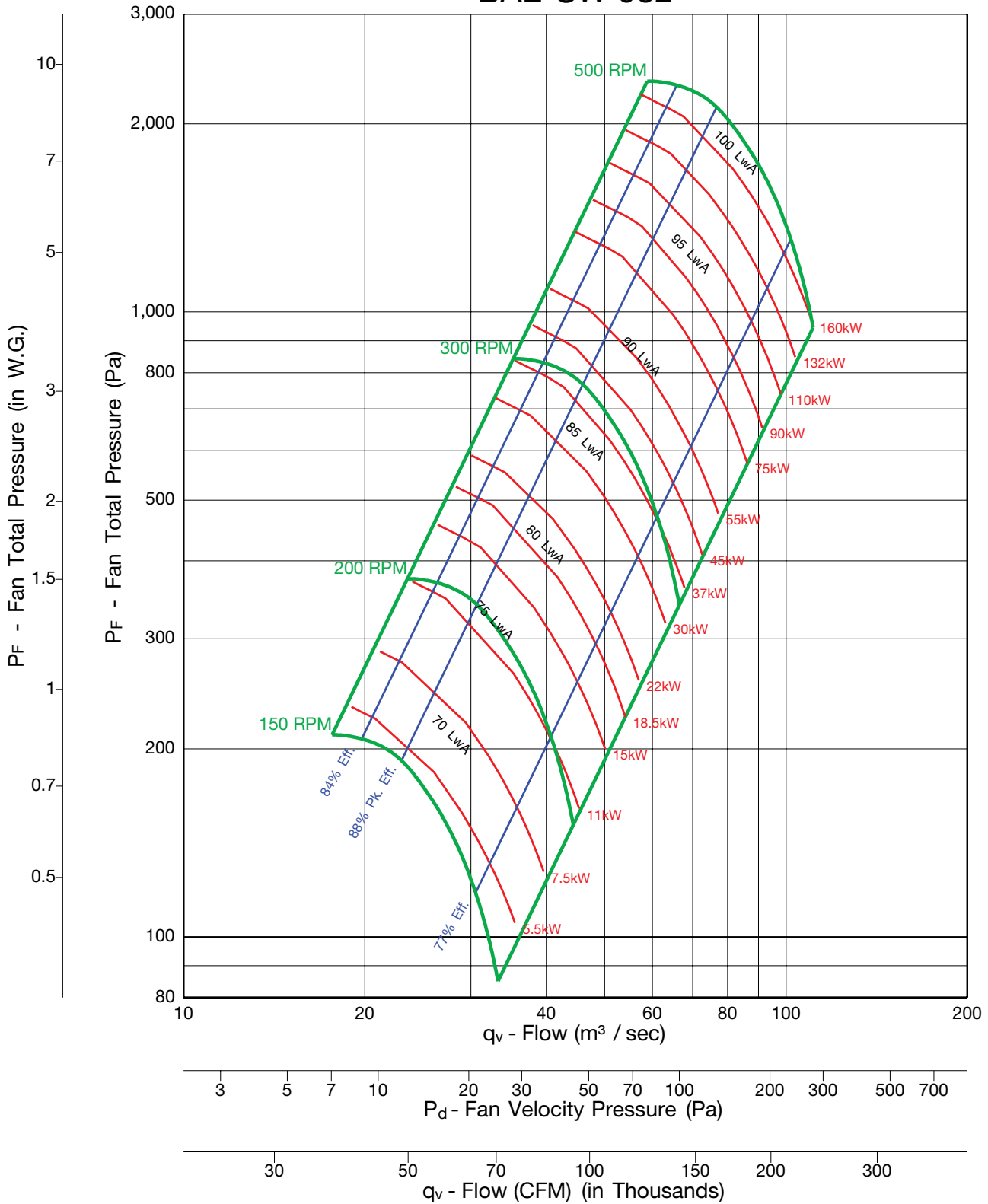

Fan Efficiency Grade = FEG 90



Notes:

1. Performance certified is for Installation Type B & D: Free or ducted inlet, ducted outlet.
2. Power rating (kW) does not include transmission losses.
3. Performance ratings do not include the effects of appurtenances (accessories).
4. The sound power level ratings shown are in decibels, referred to 10 E-12 watts calculated per AMCA Standard 301.
5. Values shown are for inlet LwA sound power levels for Installation Type B: Free inlet, ducted outlet.
6. Ratings do not include the effects of duct end correction.
7. The A-weighted sound ratings shown have been calculated per AMCA Standard 301.

BAE-DW 122

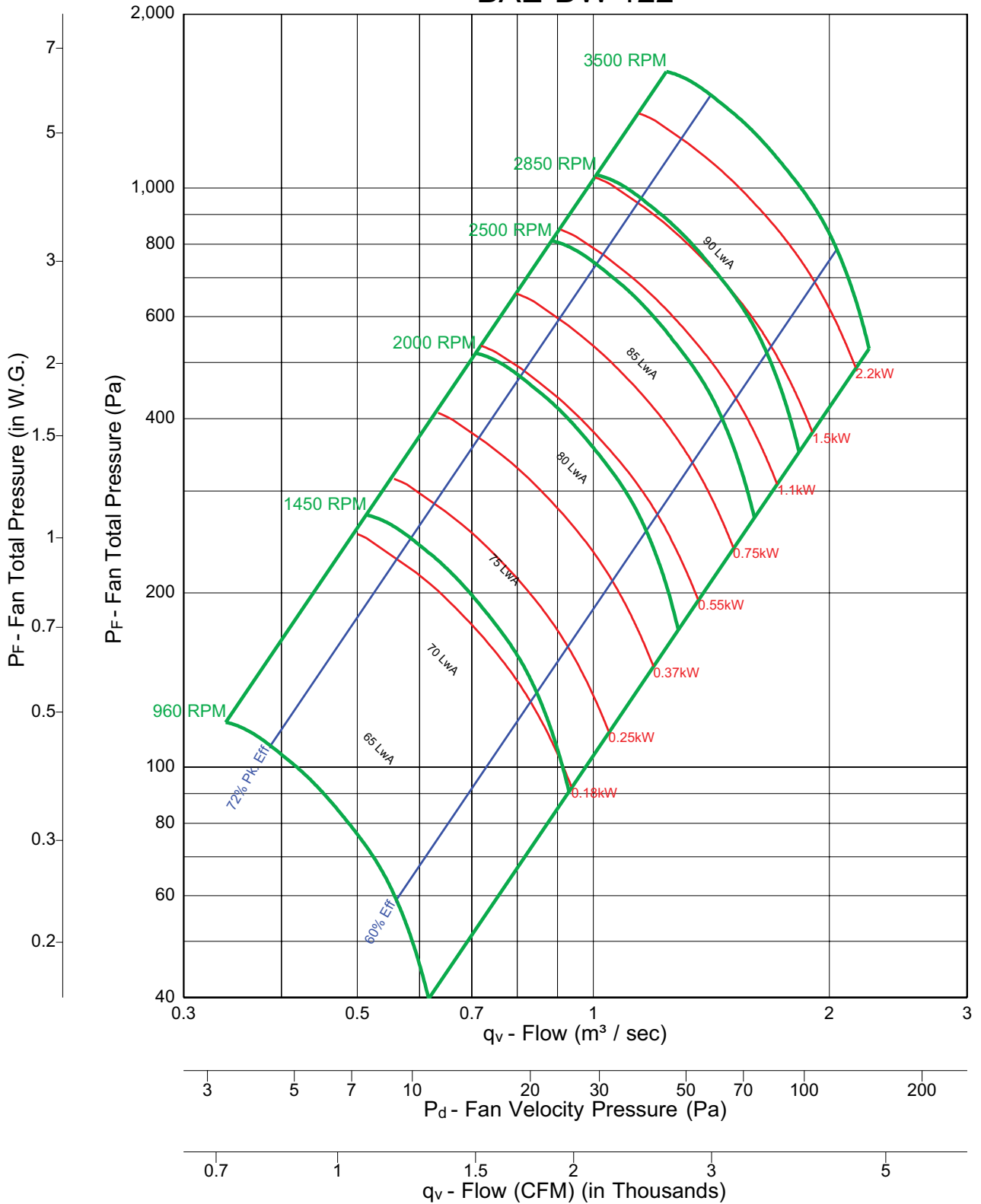

Fan Efficiency Grade = FEG 85



Notes:

1. Performance certified is for Installation Type B & D: Free or ducted inlet, ducted outlet.
2. Power rating (kW) does not include transmission losses.
3. Performance ratings do not include the effects of appurtenances (accessories).
4. The sound power level ratings shown are in decibels, referred to 10 E-12 watts calculated per AMCA Standard 301.
5. Values shown are for inlet LwA sound power levels for Installation Type B: Free inlet, ducted outlet.
6. Ratings do not include the effects of duct end correction.
7. The A-weighted sound ratings shown have been calculated per AMCA Standard 301.

BAE-DW 135

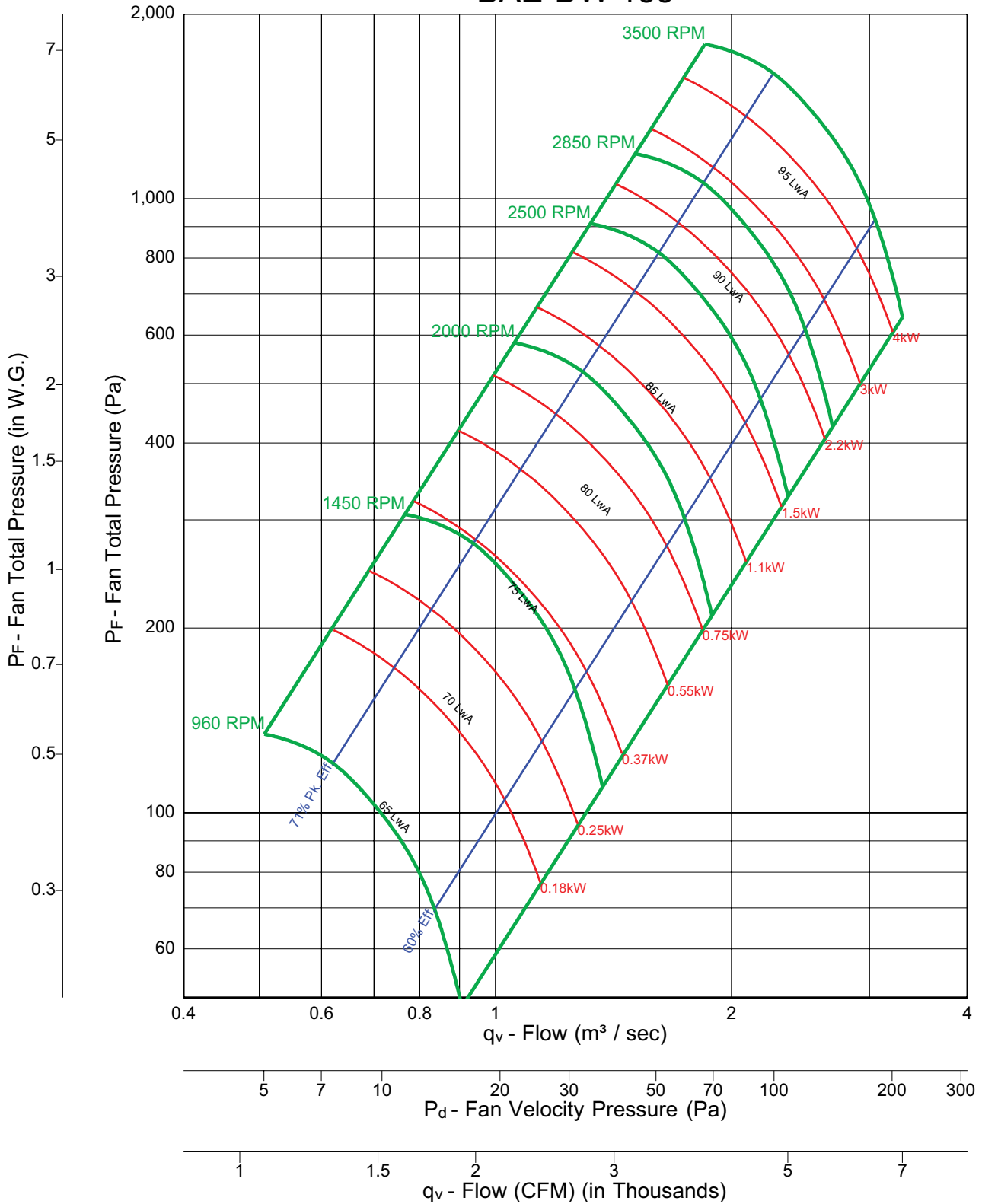

Fan Efficiency Grade = FEG 80



Notes:

1. Performance certified is for Installation Type B & D: Free or ducted inlet, ducted outlet.
2. Power rating (kW) does not include transmission losses.
3. Performance ratings do not include the effects of appurtenances (accessories).
4. The sound power level ratings shown are in decibels, referred to 10 E-12 watts calculated per AMCA Standard 301.
5. Values shown are for inlet LwA sound power levels for Installation Type B: Free inlet, ducted outlet.
6. Ratings do not include the effects of duct end correction.
7. The A-weighted sound ratings shown have been calculated per AMCA Standard 301.

BAE-DW 150

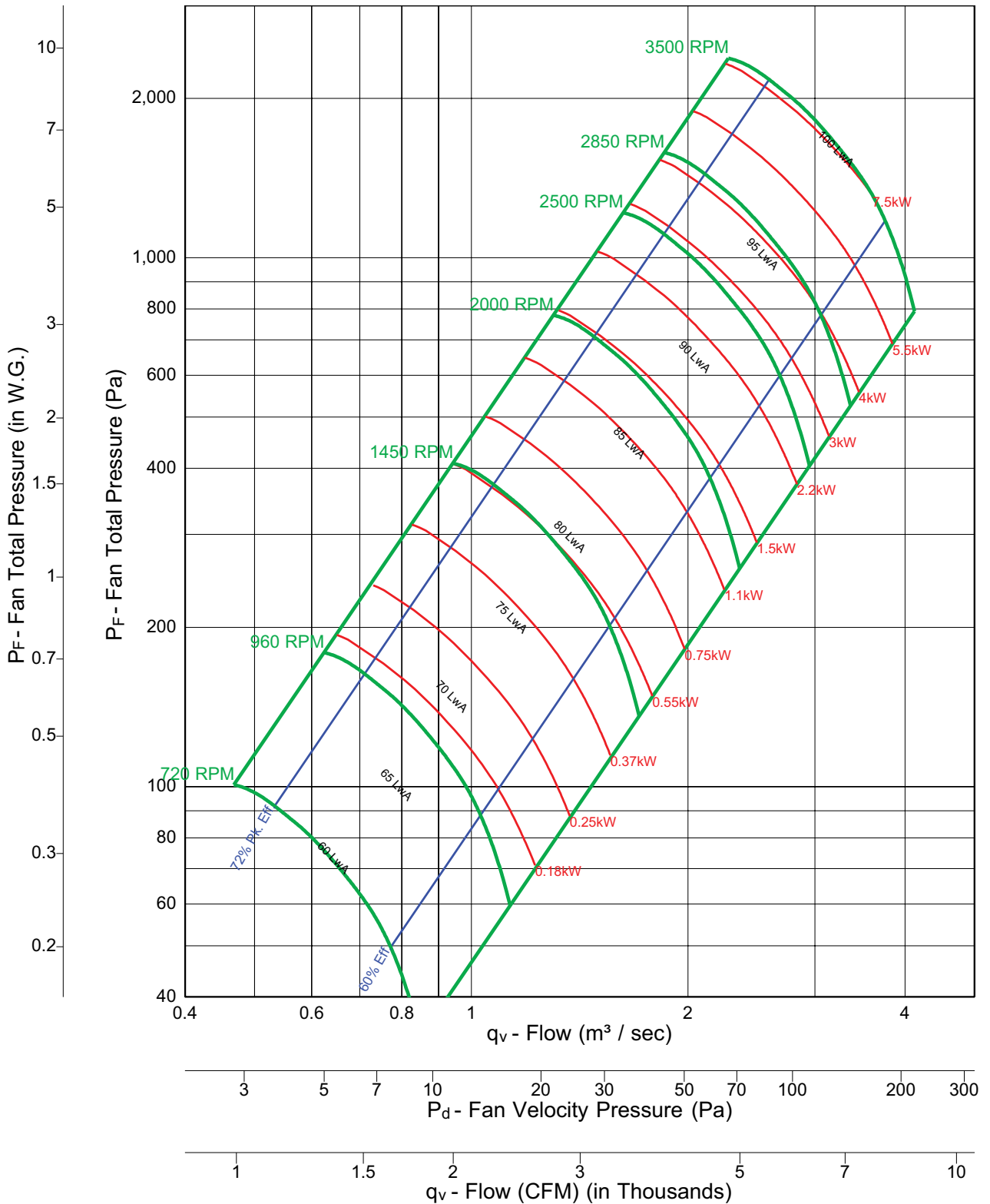

Fan Efficiency Grade = FEG 80



Notes:

1. Performance certified is for Installation Type B & D: Free or ducted inlet, ducted outlet.
2. Power rating (kW) does not include transmission losses.
3. Performance ratings do not include the effects of appurtenances (accessories).
4. The sound power level ratings shown are in decibels, referred to 10 E-12 watts calculated per AMCA Standard 301.
5. Values shown are for inlet LwA sound power levels for Installation Type B: Free inlet, ducted outlet.
6. Ratings do not include the effects of duct end correction.
7. The A-weighted sound ratings shown have been calculated per AMCA Standard 301.

BAE-DW 165

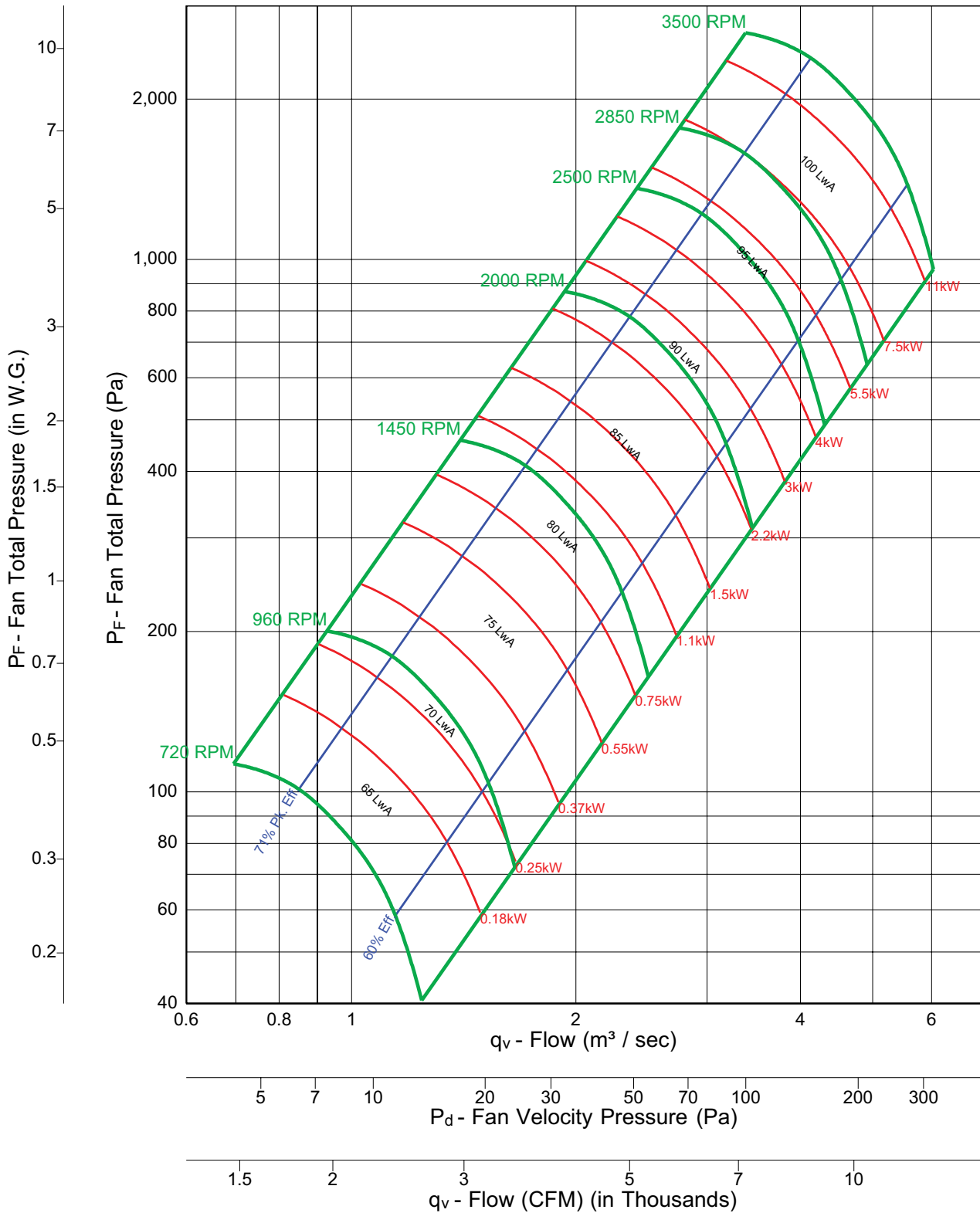

Fan Efficiency Grade = FEG 75



Notes:

1. Performance certified is for Installation Type B & D: Free or ducted inlet, ducted outlet.
2. Power rating (kW) does not include transmission losses.
3. Performance ratings do not include the effects of appurtenances (accessories).
4. The sound power level ratings shown are in decibels, referred to 10 E-12 watts calculated per AMCA Standard 301.
5. Values shown are for inlet LwA sound power levels for Installation Type B: Free inlet, ducted outlet.
6. Ratings do not include the effects of duct end correction.
7. The A-weighted sound ratings shown have been calculated per AMCA Standard 301.

BAE-DW 182

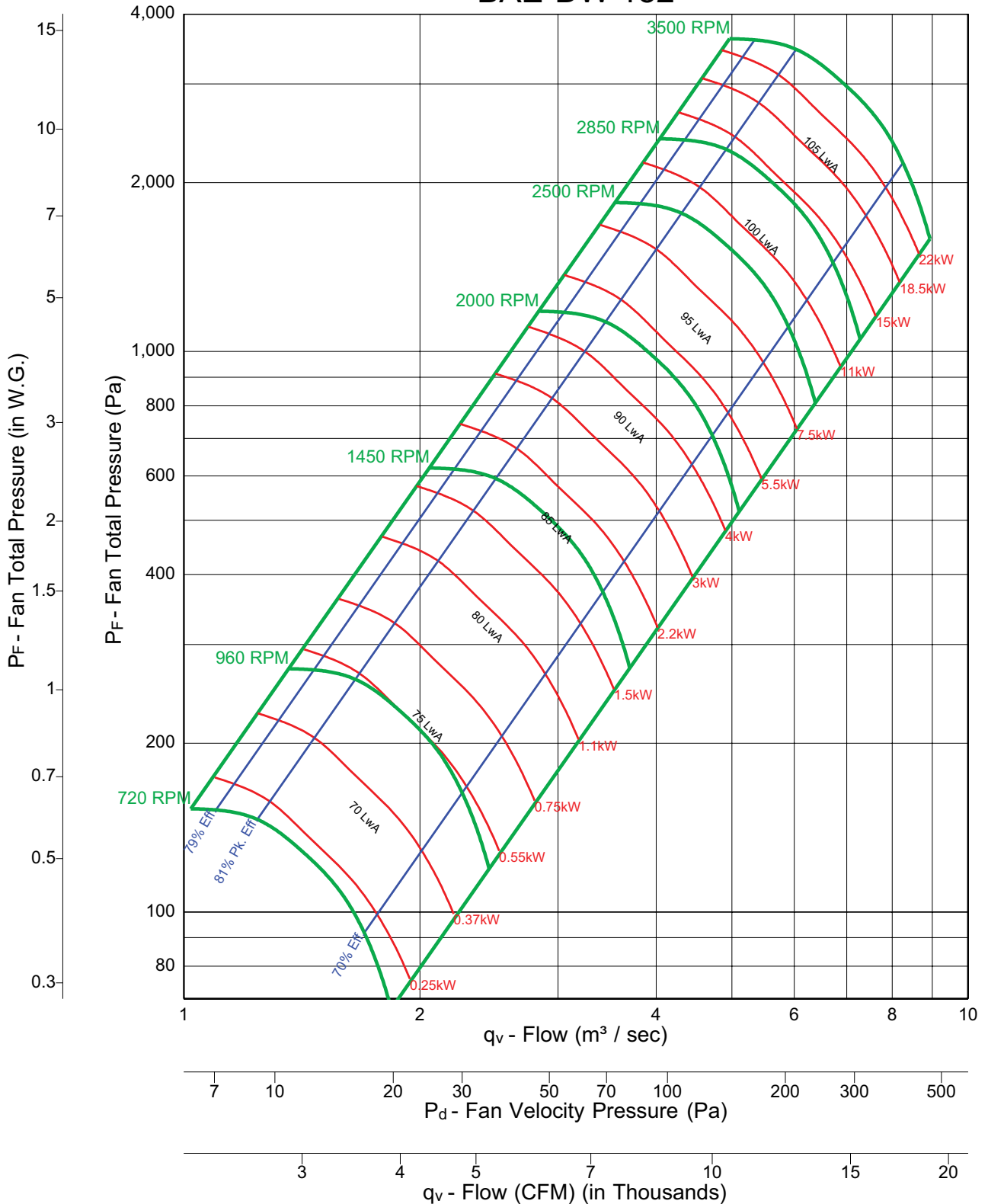

Fan Efficiency Grade = FEG 90



Notes:

1. Performance certified is for Installation Type B & D: Free or ducted inlet, ducted outlet.
2. Power rating (kW) does not include transmission losses.
3. Performance ratings do not include the effects of appurtenances (accessories).
4. The sound power level ratings shown are in decibels, referred to 10 E-12 watts calculated per AMCA Standard 301.
5. Values shown are for inlet LwA sound power levels for Installation Type B: Free inlet, ducted outlet.
6. Ratings do not include the effects of duct end correction.
7. The A-weighted sound ratings shown have been calculated per AMCA Standard 301.

BAE-DW 200

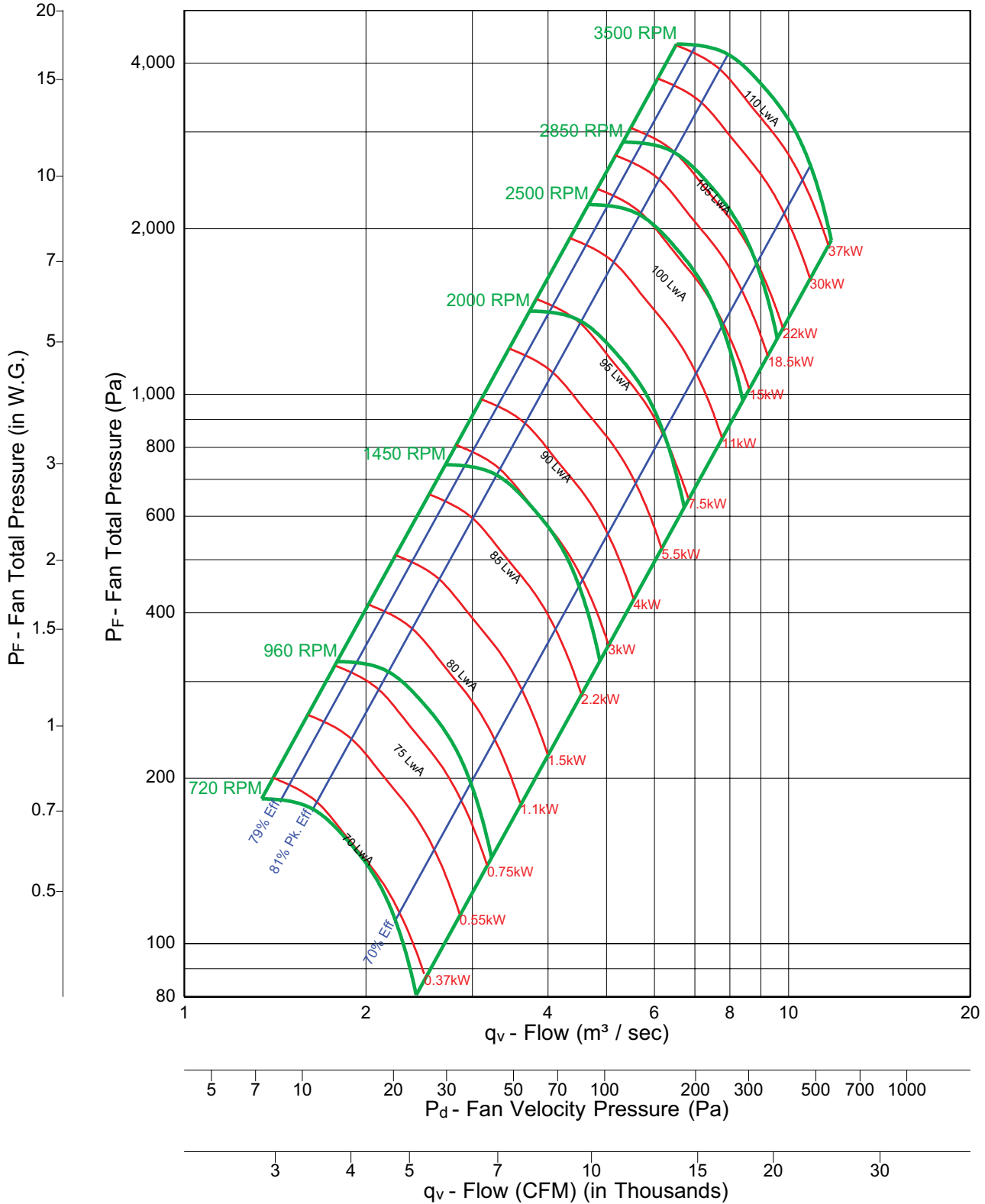

Fan Efficiency Grade = FEG 85



Notes:

1. Performance certified is for Installation Type B & D: Free or ducted inlet, ducted outlet.
2. Power rating (kW) does not include transmission losses.
3. Performance ratings do not include the effects of appurtenances (accessories).
4. The sound power level ratings shown are in decibels, referred to 10 E-12 watts calculated per AMCA Standard 301.
5. Values shown are for inlet LwA sound power levels for Installation Type B: Free inlet, ducted outlet.
6. Ratings do not include the effects of duct end correction.
7. The A-weighted sound ratings shown have been calculated per AMCA Standard 301.

BAE-DW 222

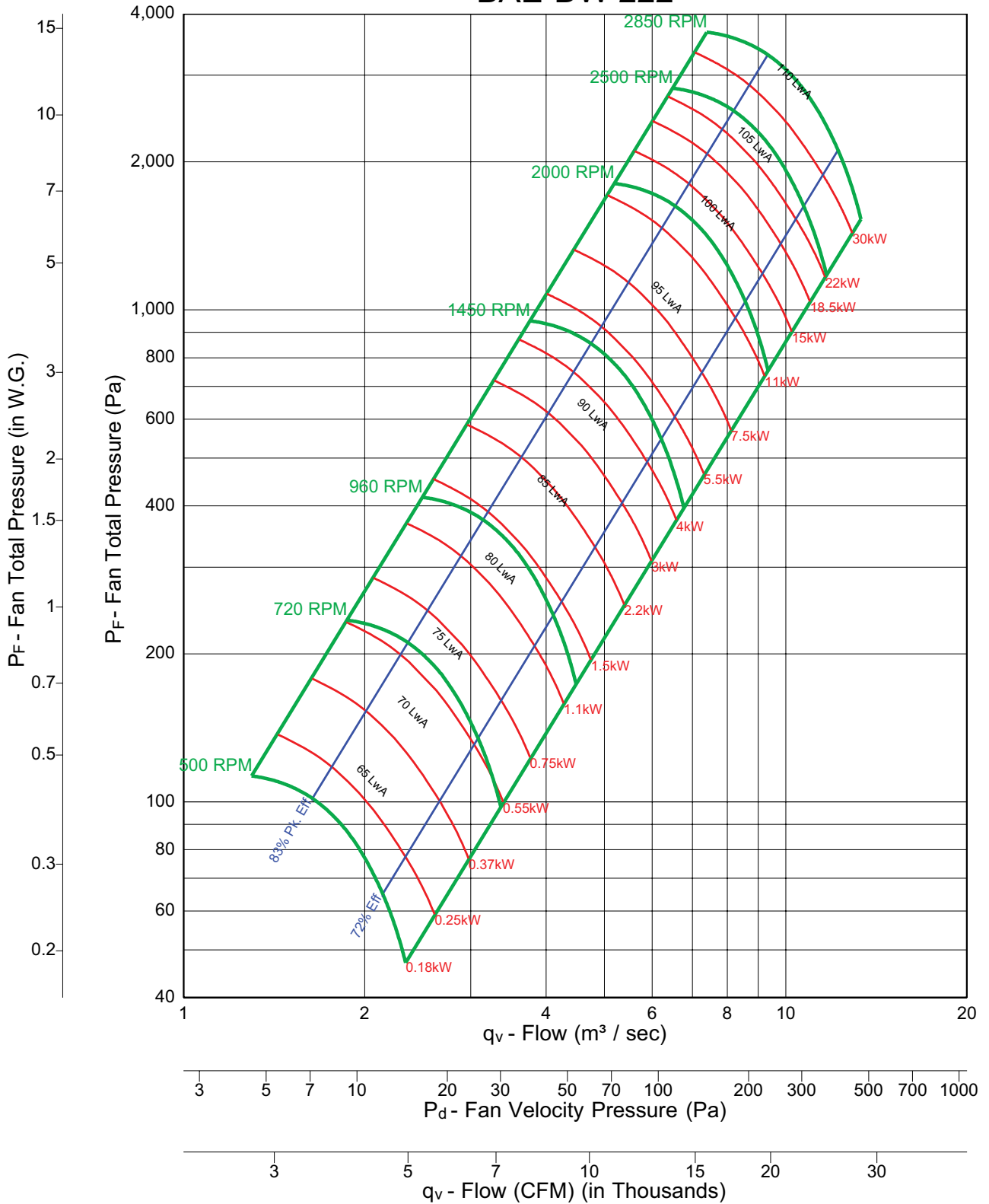

Fan Efficiency Grade = FEG 90



Notes:

1. Performance certified is for Installation Type B & D: Free or ducted inlet, ducted outlet.
2. Power rating (kW) does not include transmission losses.
3. Performance ratings do not include the effects of appurtenances (accessories).
4. The sound power level ratings shown are in decibels, referred to 10 E-12 watts calculated per AMCA Standard 301.
5. Values shown are for inlet LwA sound power levels for Installation Type B: Free inlet, ducted outlet.
6. Ratings do not include the effects of duct end correction.
7. The A-weighted sound ratings shown have been calculated per AMCA Standard 301.

BAE-DW 245

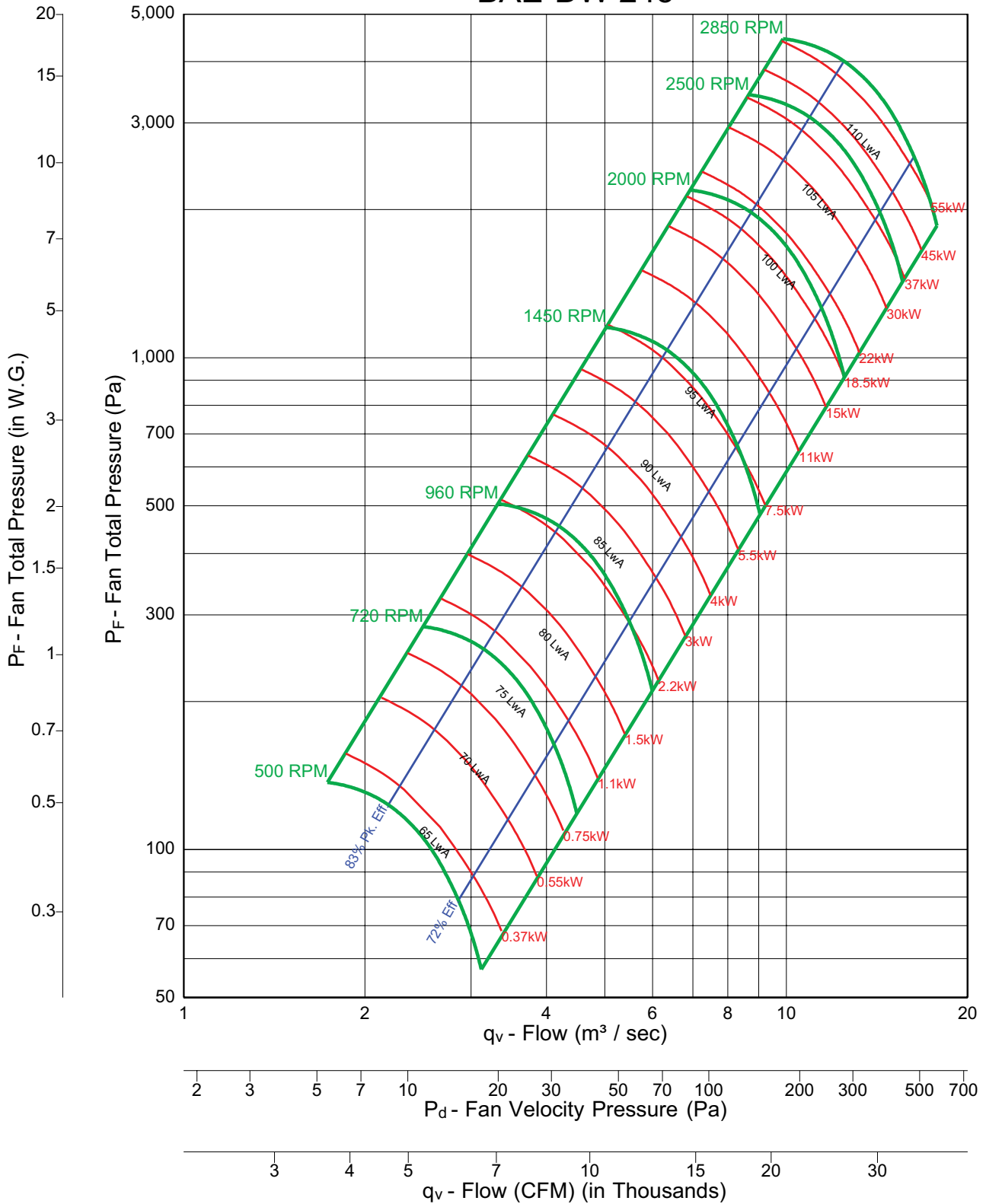

Fan Efficiency Grade = FEG 85



Notes:

1. Performance certified is for Installation Type B & D: Free or ducted inlet, ducted outlet.
2. Power rating (kW) does not include transmission losses.
3. Performance ratings do not include the effects of appurtenances (accessories).
4. The sound power level ratings shown are in decibels, referred to 10 E-12 watts calculated per AMCA Standard 301.
5. Values shown are for inlet LwA sound power levels for Installation Type B: Free inlet, ducted outlet.
6. Ratings do not include the effects of duct end correction.
7. The A-weighted sound ratings shown have been calculated per AMCA Standard 301.

BAE-DW 270

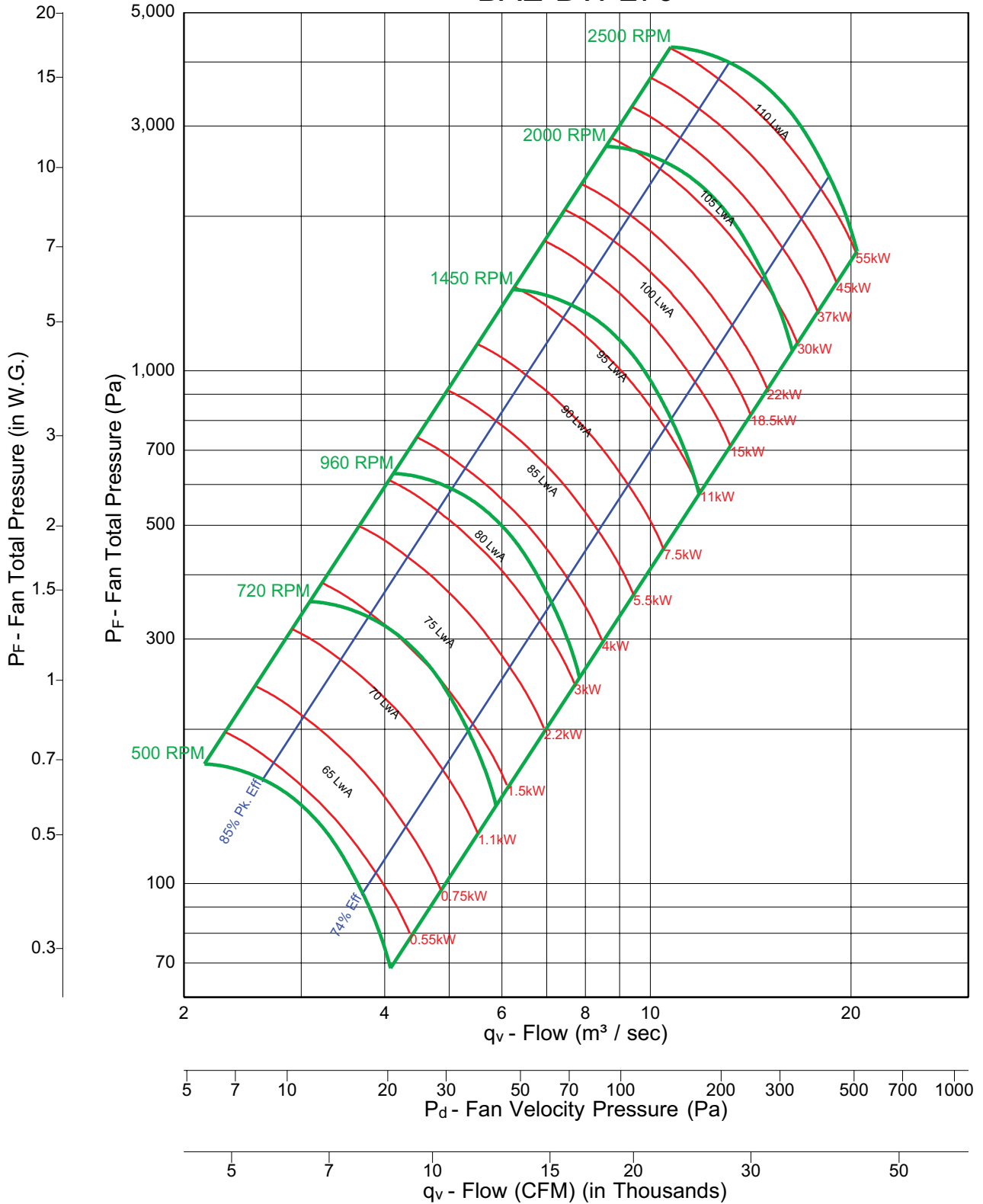

Fan Efficiency Grade = FEG 90



Notes:

1. Performance certified is for Installation Type B & D: Free or ducted inlet, ducted outlet.
2. Power rating (kW) does not include transmission losses.
3. Performance ratings do not include the effects of appurtenances (accessories).
4. The sound power level ratings shown are in decibels, referred to 10 E-12 watts calculated per AMCA Standard 301.
5. Values shown are for inlet LwA sound power levels for Installation Type B: Free inlet, ducted outlet.
6. Ratings do not include the effects of duct end correction.
7. The A-weighted sound ratings shown have been calculated per AMCA Standard 301.

BAE-DW 300

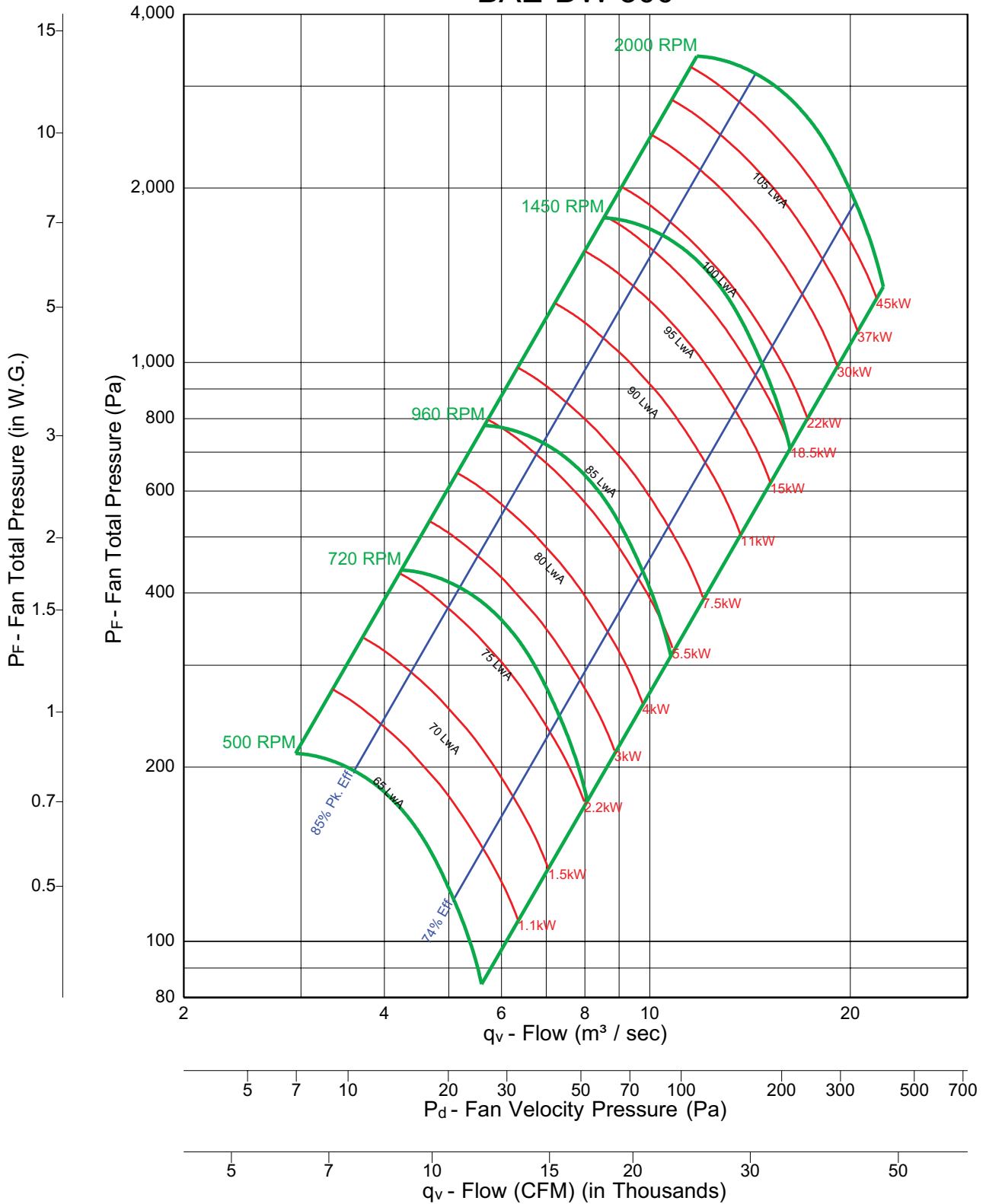

Fan Efficiency Grade = FEG 90



Notes:

1. Performance certified is for Installation Type B & D: Free or ducted inlet, ducted outlet.
2. Power rating (kW) does not include transmission losses.
3. Performance ratings do not include the effects of appurtenances (accessories).
4. The sound power level ratings shown are in decibels, referred to 10 E-12 watts calculated per AMCA Standard 301.
5. Values shown are for inlet LwA sound power levels for Installation Type B: Free inlet, ducted outlet.
6. Ratings do not include the effects of duct end correction.
7. The A-weighted sound ratings shown have been calculated per AMCA Standard 301.

BAE-DW 330

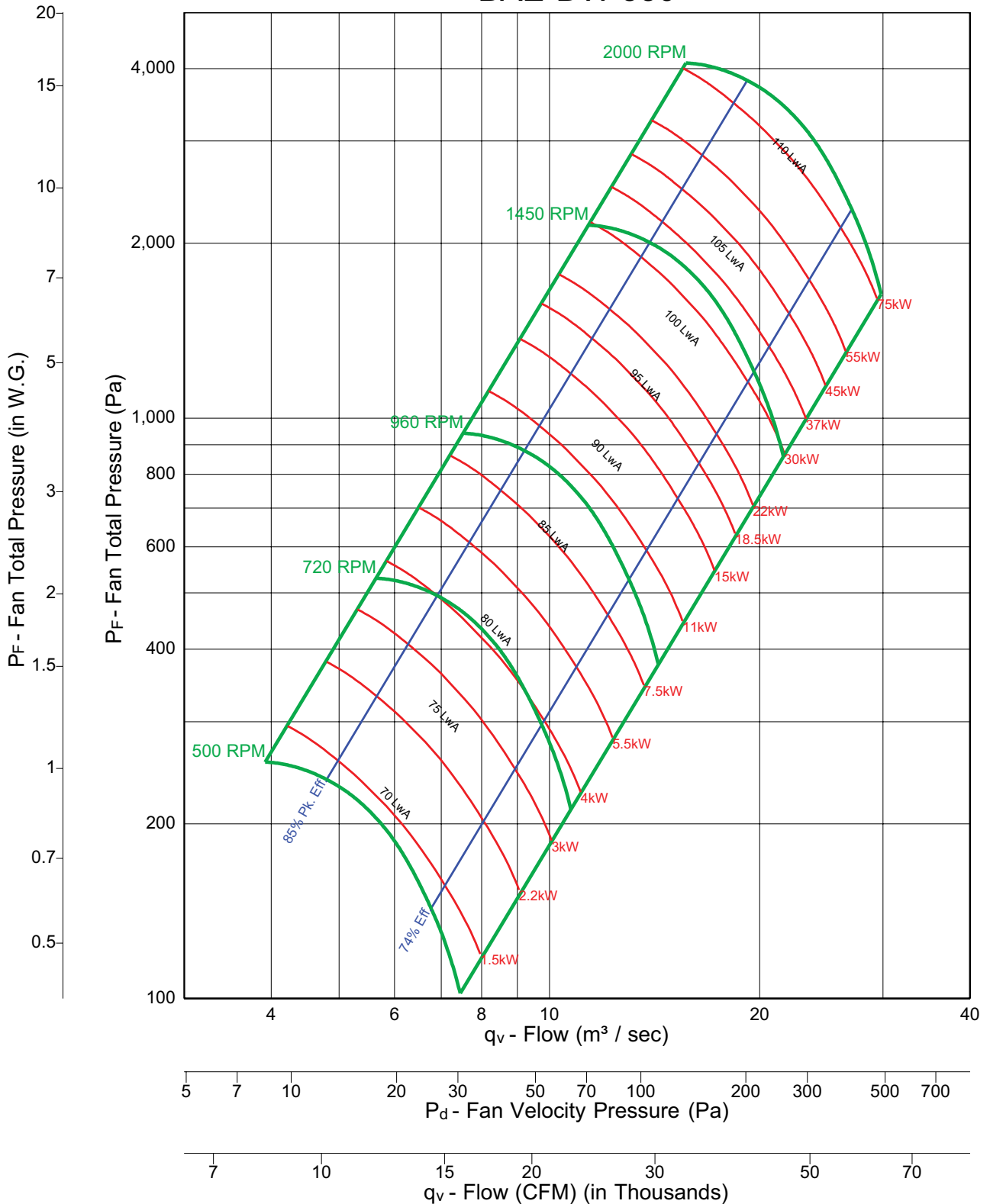

Fan Efficiency Grade = FEG 90



Notes:

1. Performance certified is for Installation Type B & D: Free or ducted inlet, ducted outlet.
2. Power rating (kW) does not include transmission losses.
3. Performance ratings do not include the effects of appurtenances (accessories).
4. The sound power level ratings shown are in decibels, referred to 10 E-12 watts calculated per AMCA Standard 301.
5. Values shown are for inlet LwA sound power levels for Installation Type B: Free inlet, ducted outlet.
6. Ratings do not include the effects of duct end correction.
7. The A-weighted sound ratings shown have been calculated per AMCA Standard 301.

BAE-DW 365

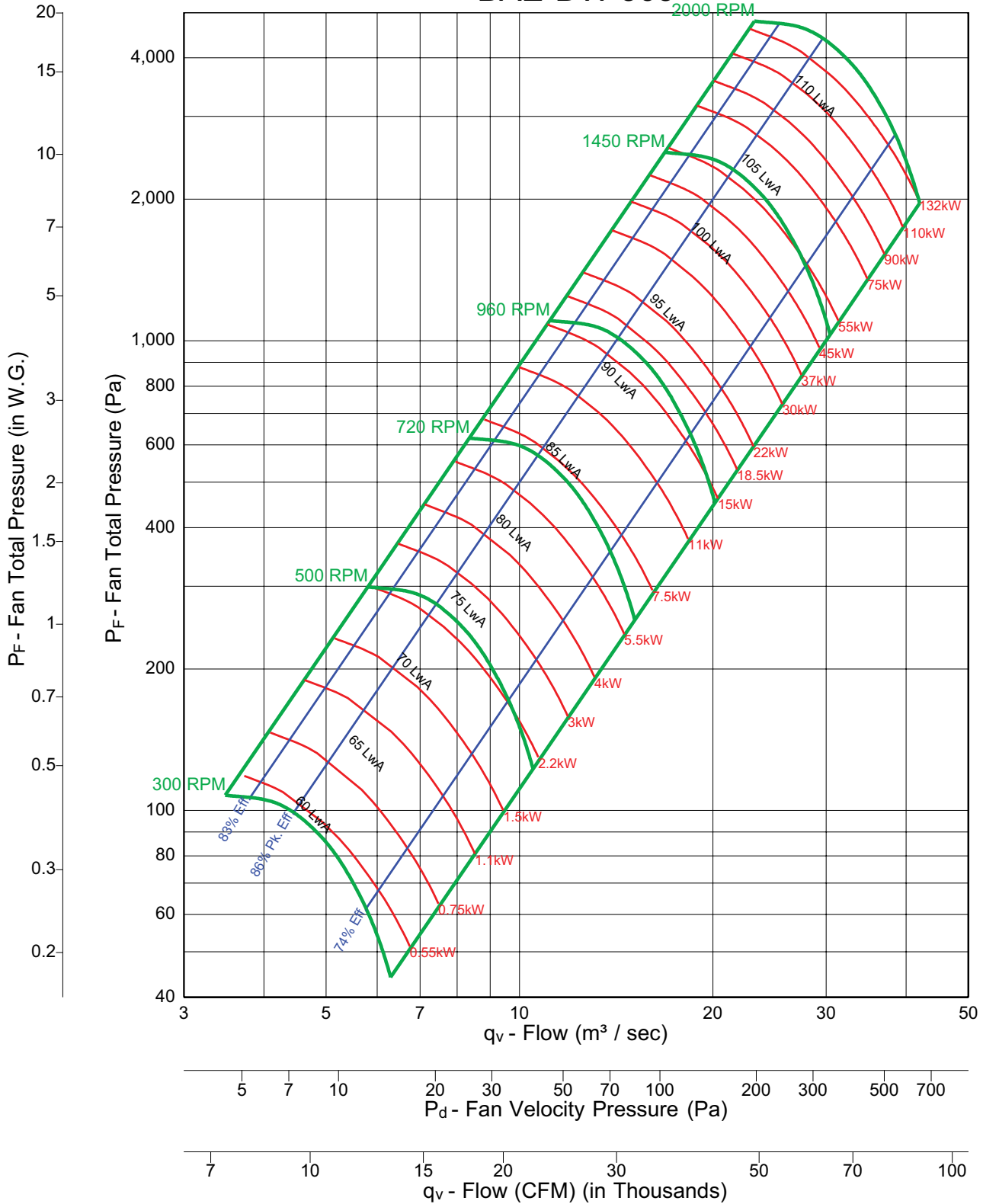

Fan Efficiency Grade = FEG 90



Notes:

1. Performance certified is for Installation Type B & D: Free or ducted inlet, ducted outlet.
2. Power rating (kW) does not include transmission losses.
3. Performance ratings do not include the effects of appurtenances (accessories).
4. The sound power level ratings shown are in decibels, referred to 10 E-12 watts calculated per AMCA Standard 301.
5. Values shown are for inlet LwA sound power levels for Installation Type B: Free inlet, ducted outlet.
6. Ratings do not include the effects of duct end correction.
7. The A-weighted sound ratings shown have been calculated per AMCA Standard 301.

BAE-DW 402

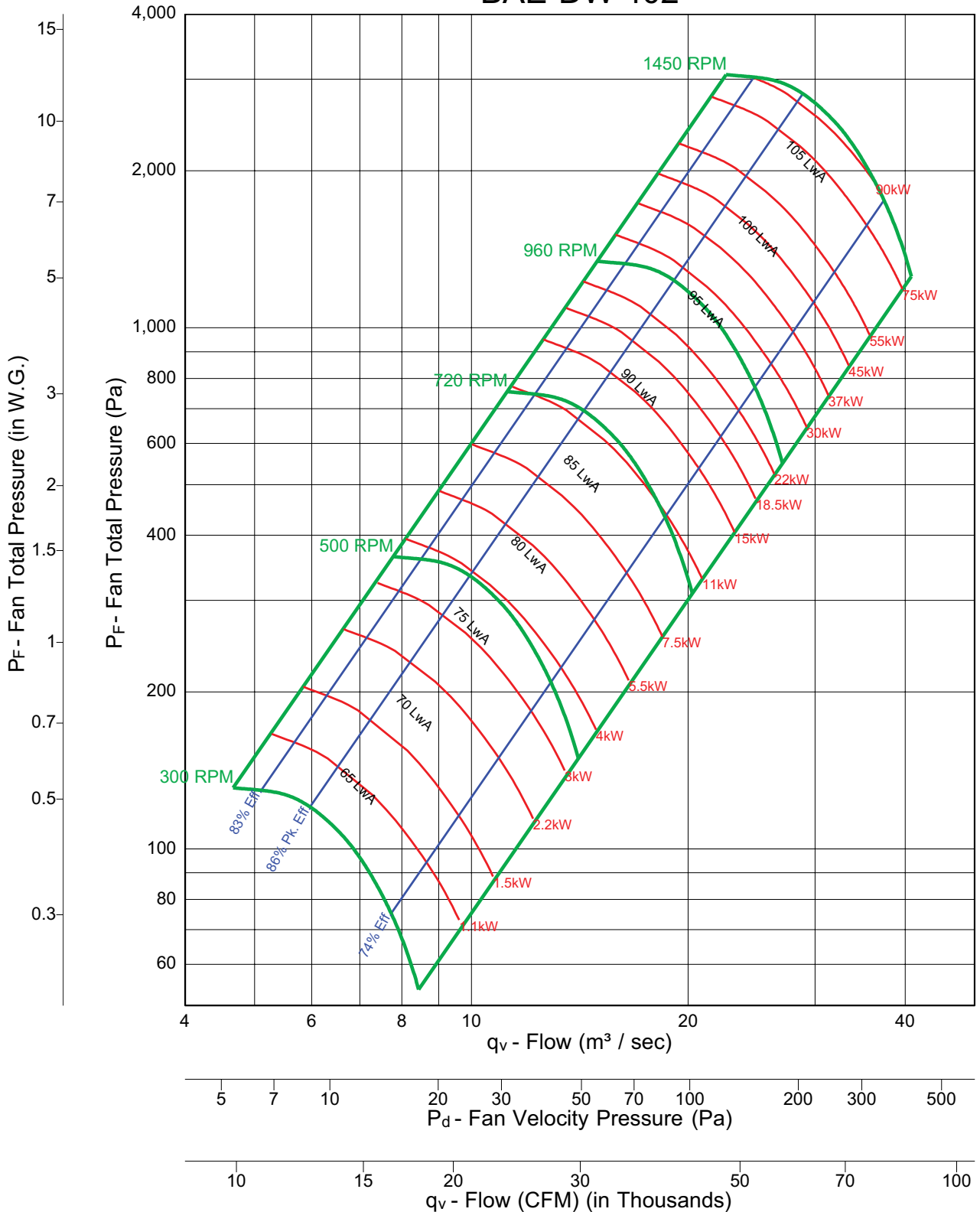

Fan Efficiency Grade = FEG 90



Notes:

1. Performance certified is for Installation Type B & D: Free or ducted inlet, ducted outlet.
2. Power rating (kW) does not include transmission losses.
3. Performance ratings do not include the effects of appurtenances (accessories).
4. The sound power level ratings shown are in decibels, referred to 10 E-12 watts calculated per AMCA Standard 301.
5. Values shown are for inlet LwA sound power levels for Installation Type B: Free inlet, ducted outlet.
6. Ratings do not include the effects of duct end correction.
7. The A-weighted sound ratings shown have been calculated per AMCA Standard 301.

BAE-DW 445

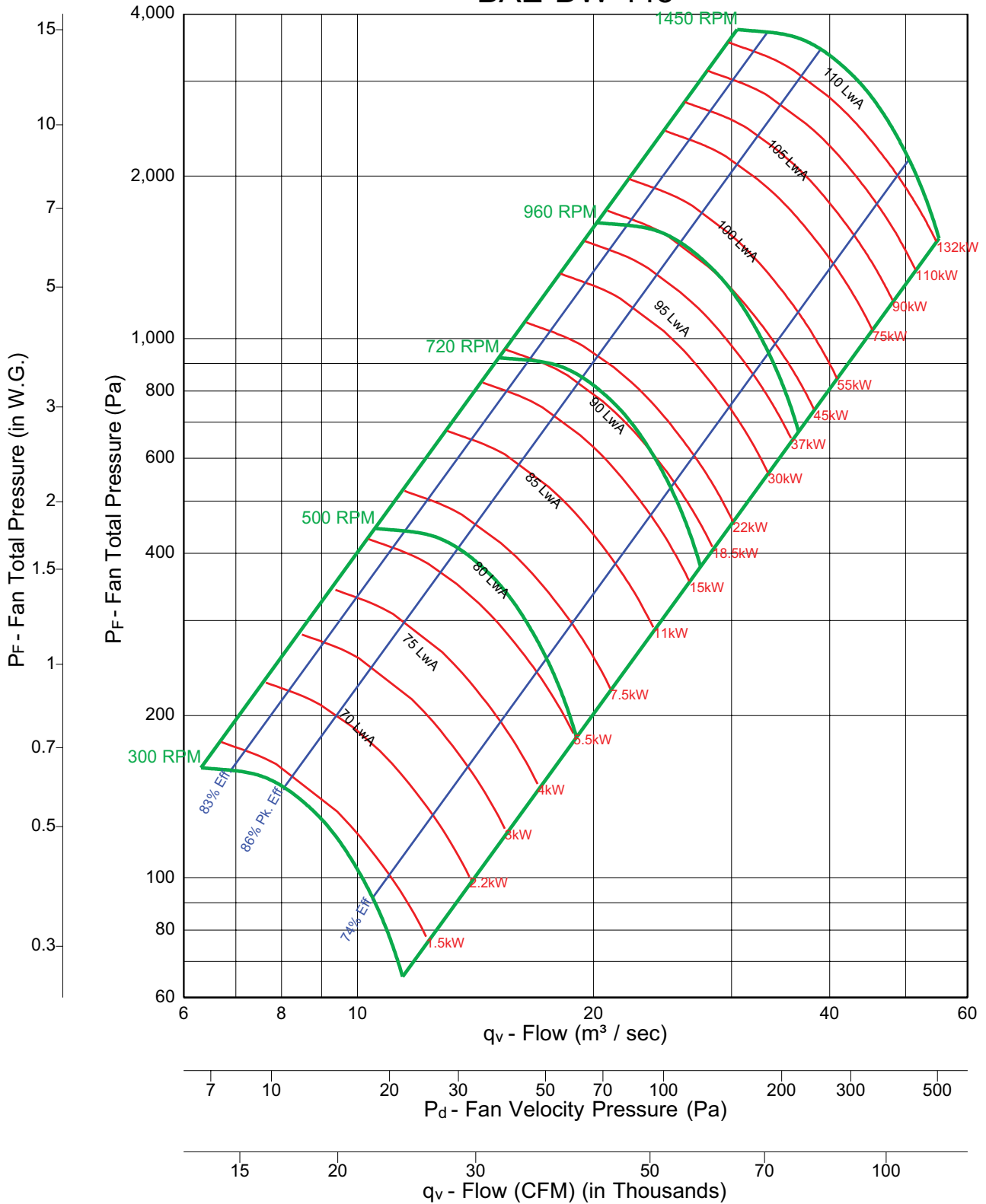

Fan Efficiency Grade = FEG 90



Notes:

1. Performance certified is for Installation Type B & D: Free or ducted inlet, ducted outlet.
2. Power rating (kW) does not include transmission losses.
3. Performance ratings do not include the effects of appurtenances (accessories).
4. The sound power level ratings shown are in decibels, referred to 10 E-12 watts calculated per AMCA Standard 301.
5. Values shown are for inlet LwA sound power levels for Installation Type B: Free inlet, ducted outlet.
6. Ratings do not include the effects of duct end correction.
7. The A-weighted sound ratings shown have been calculated per AMCA Standard 301.

BAE-DW 490

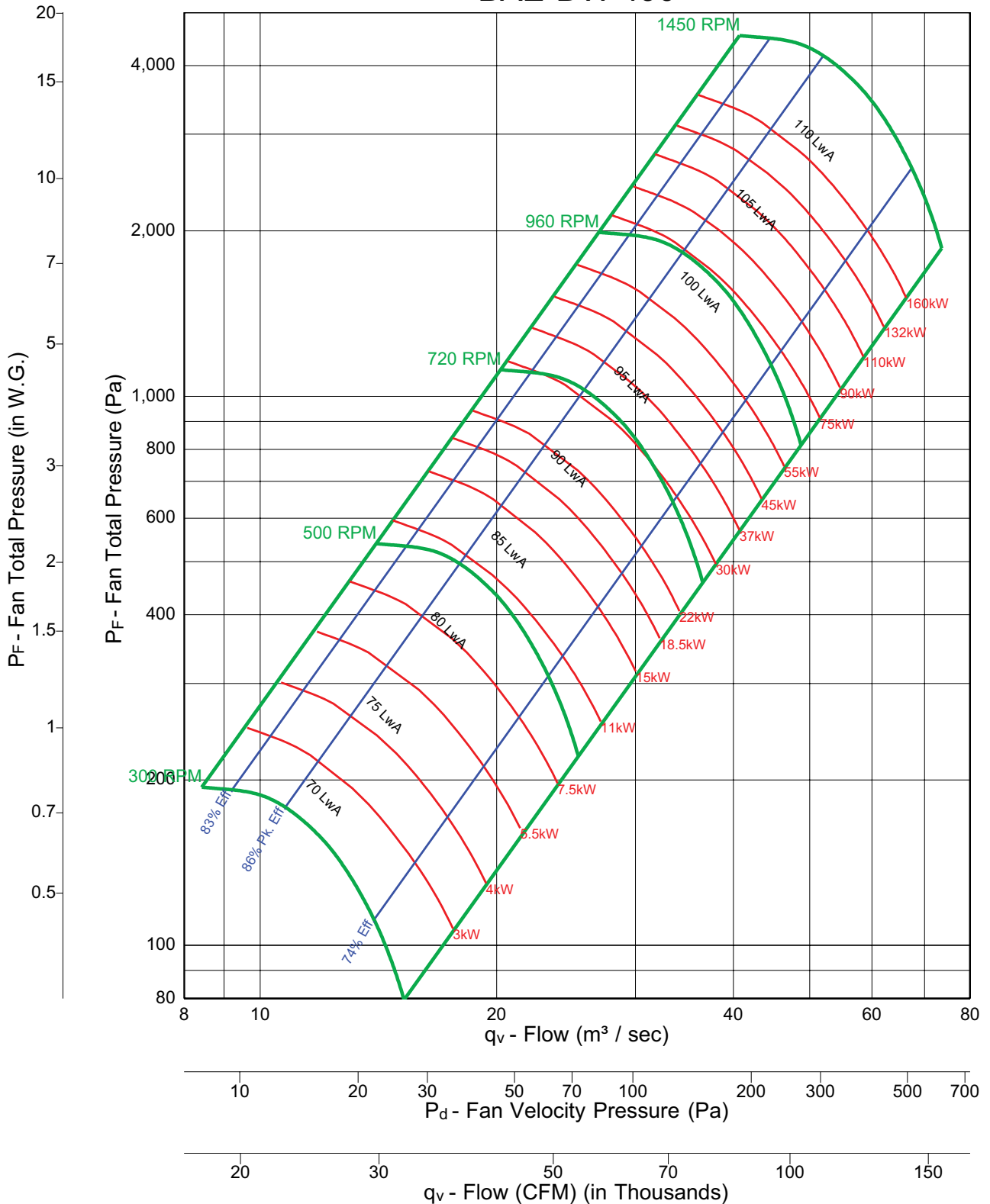

Fan Efficiency Grade = FEG 90



Notes:

1. Performance certified is for Installation Type B & D: Free or ducted inlet, ducted outlet.
2. Power rating (kW) does not include transmission losses.
3. Performance ratings do not include the effects of appurtenances (accessories).
4. The sound power level ratings shown are in decibels, referred to 10 E-12 watts calculated per AMCA Standard 301.
5. Values shown are for inlet LwA sound power levels for Installation Type B: Free inlet, ducted outlet.
6. Ratings do not include the effects of duct end correction.
7. The A-weighted sound ratings shown have been calculated per AMCA Standard 301.

BAE-DW 542

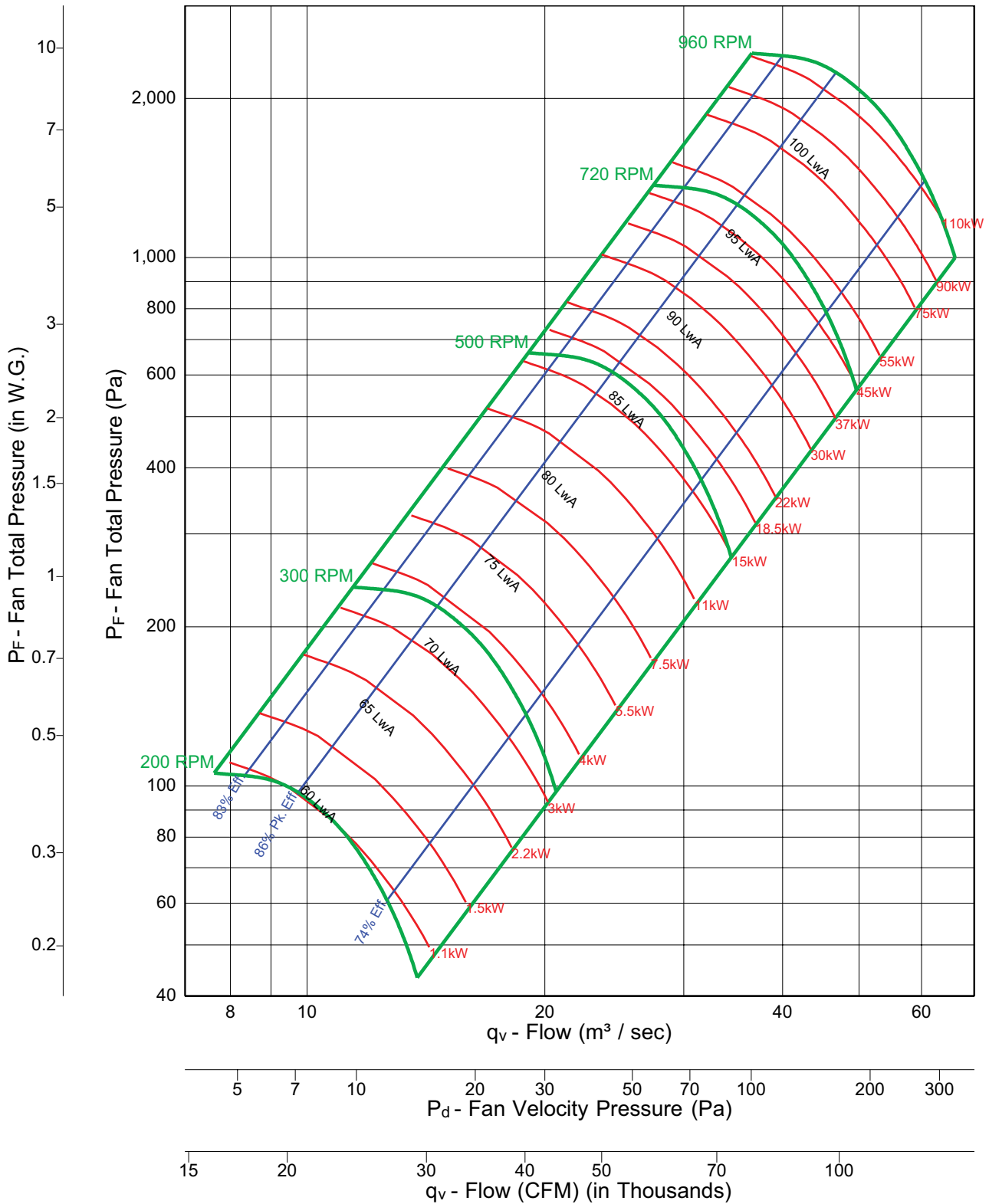

Fan Efficiency Grade = FEG 90



Notes:

1. Performance certified is for Installation Type B & D: Free or ducted inlet, ducted outlet.
2. Power rating (kW) does not include transmission losses.
3. Performance ratings do not include the effects of appurtenances (accessories).
4. The sound power level ratings shown are in decibels, referred to 10 E-12 watts calculated per AMCA Standard 301.
5. Values shown are for inlet LwA sound power levels for Installation Type B: Free inlet, ducted outlet.
6. Ratings do not include the effects of duct end correction.
7. The A-weighted sound ratings shown have been calculated per AMCA Standard 301.

BAE-DW 600

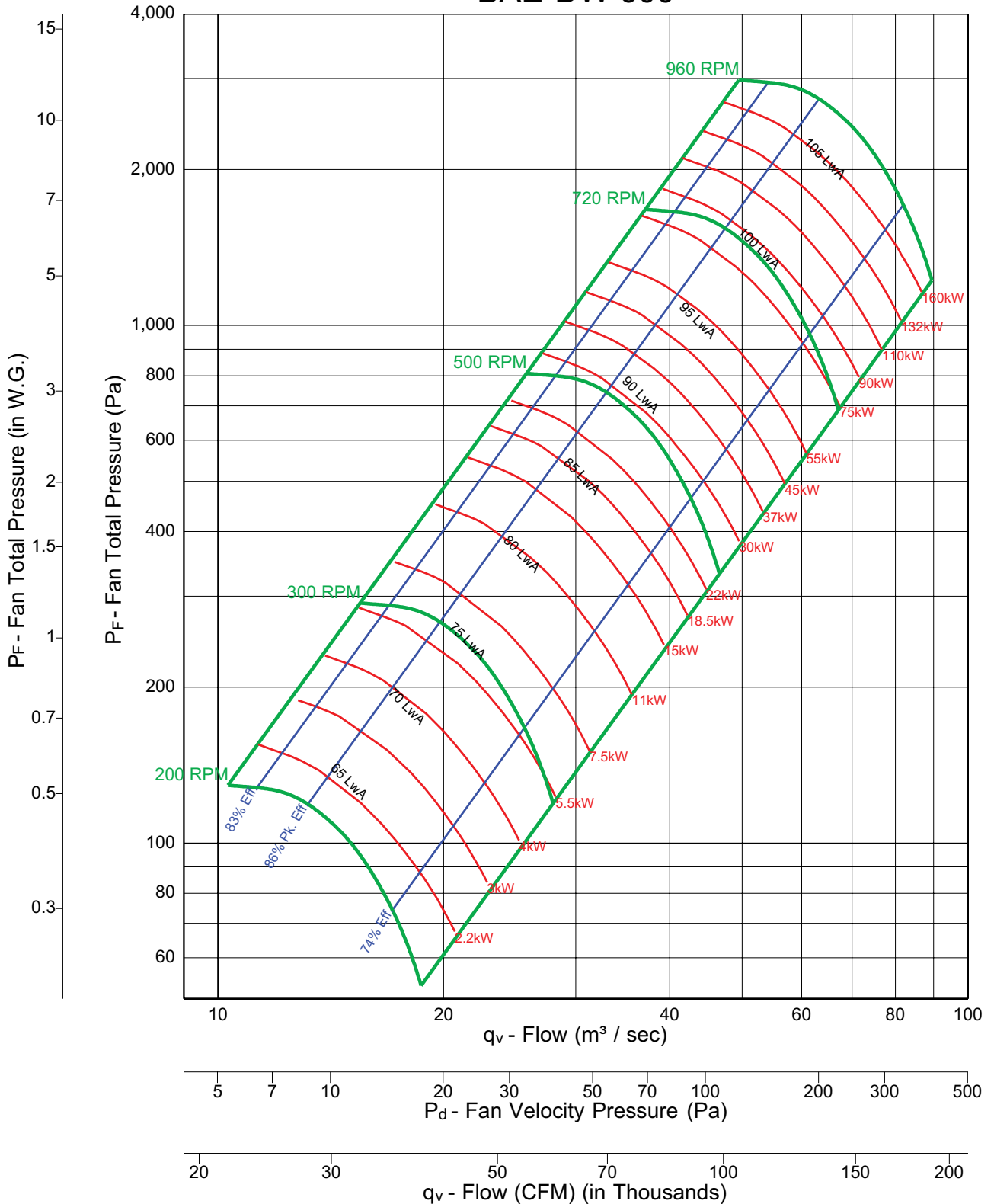

Fan Efficiency Grade = FEG 90



Notes:

1. Performance certified is for Installation Type B & D: Free or ducted inlet, ducted outlet.
2. Power rating (kW) does not include transmission losses.
3. Performance ratings do not include the effects of appurtenances (accessories).
4. The sound power level ratings shown are in decibels, referred to 10 E-12 watts calculated per AMCA Standard 301.
5. Values shown are for inlet LwA sound power levels for Installation Type B: Free inlet, ducted outlet.
6. Ratings do not include the effects of duct end correction.
7. The A-weighted sound ratings shown have been calculated per AMCA Standard 301.

BAE-DW 660

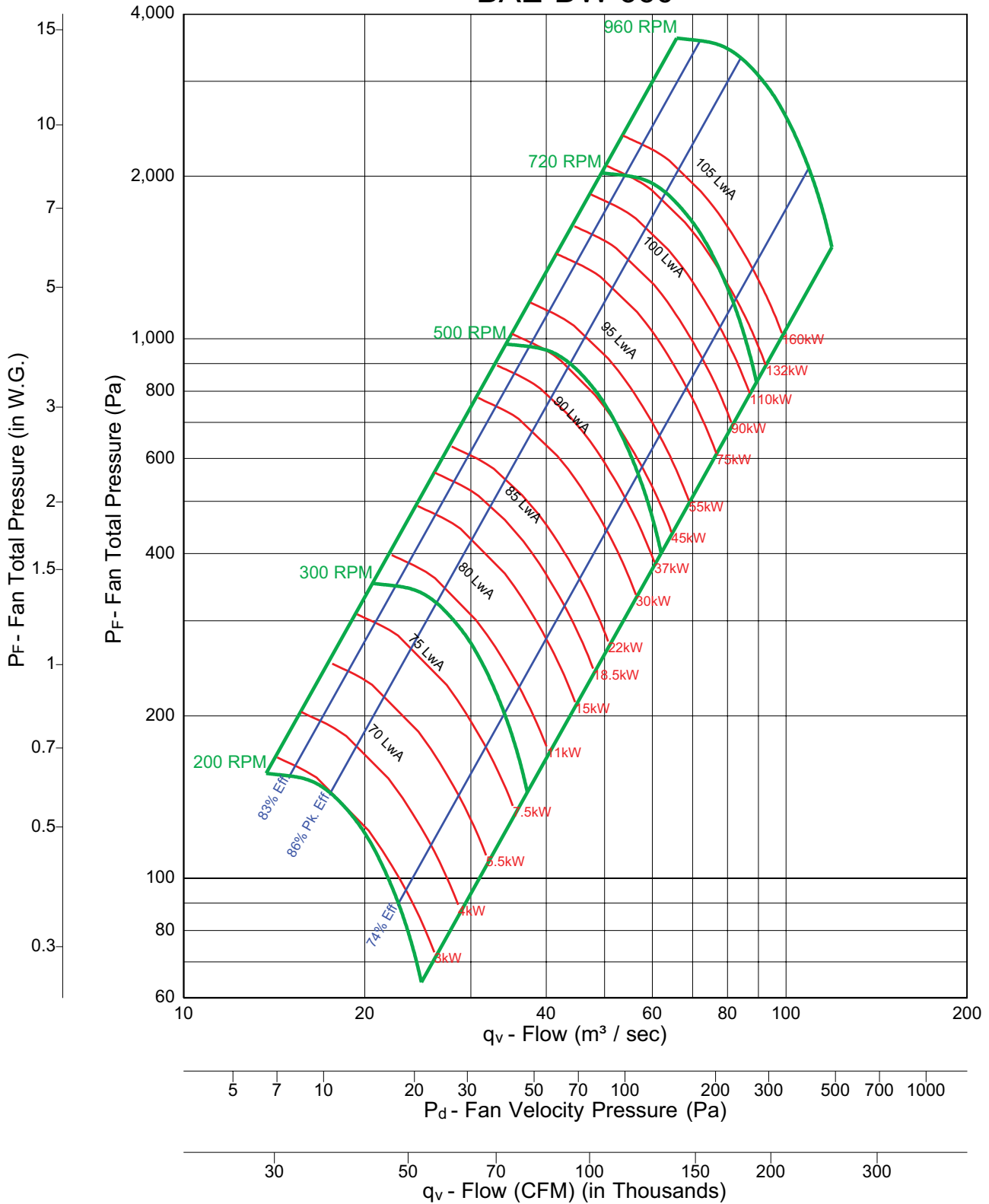

Fan Efficiency Grade = FEG 90



Notes:

1. Performance certified is for Installation Type B & D: Free or ducted inlet, ducted outlet.
2. Power rating (kW) does not include transmission losses.
3. Performance ratings do not include the effects of appurtenances (accessories).
4. The sound power level ratings shown are in decibels, referred to 10 E-12 watts calculated per AMCA Standard 301.
5. Values shown are for inlet LwA sound power levels for Installation Type B: Free inlet, ducted outlet.
6. Ratings do not include the effects of duct end correction.
7. The A-weighted sound ratings shown have been calculated per AMCA Standard 301.

BAE-DW 730

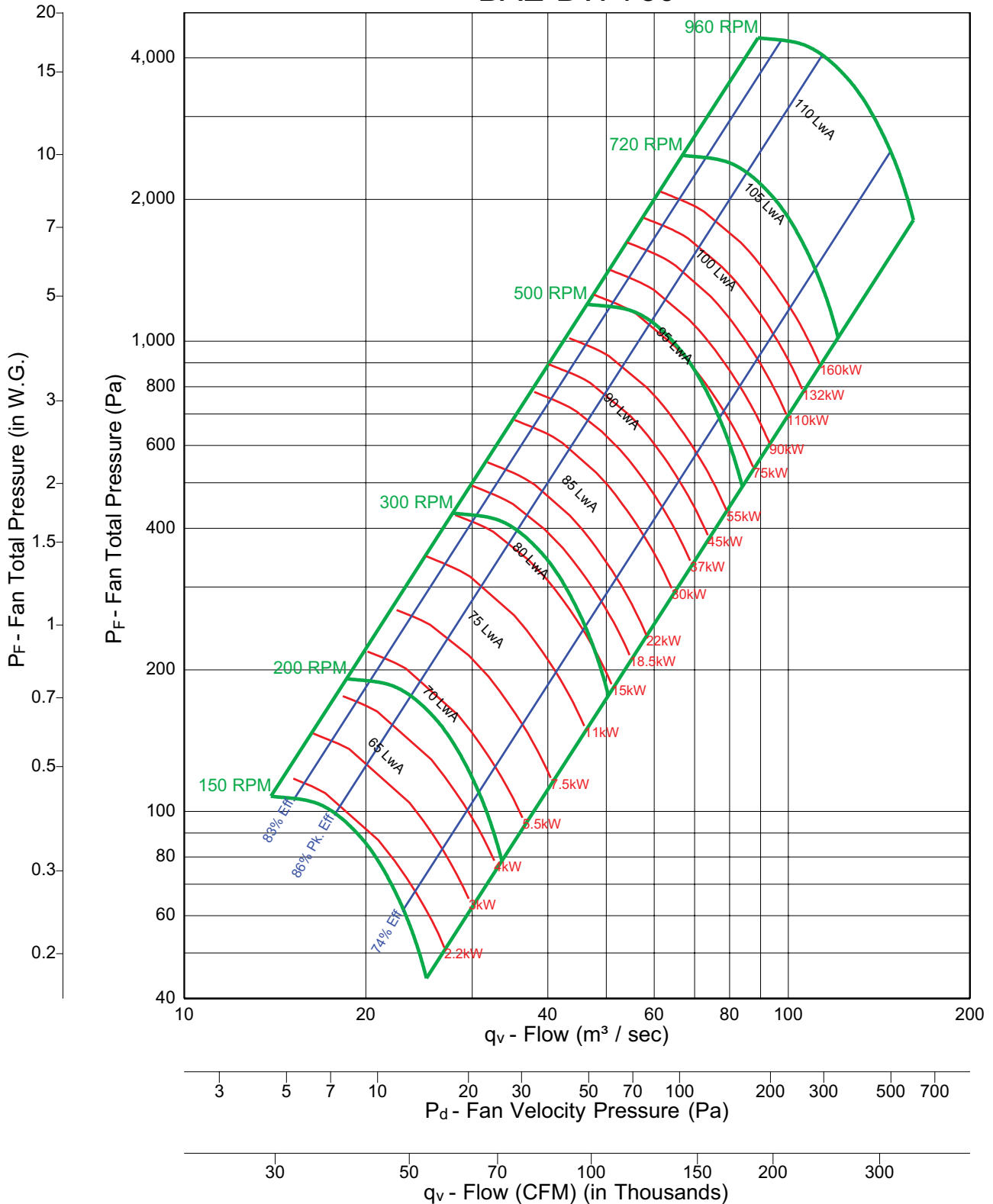

Fan Efficiency Grade = FEG 90



Notes:

1. Performance certified is for Installation Type B & D: Free or ducted inlet, ducted outlet.
2. Power rating (kW) does not include transmission losses.
3. Performance ratings do not include the effects of appurtenances (accessories).
4. The sound power level ratings shown are in decibels, referred to 10 E-12 watts calculated per AMCA Standard 301.
5. Values shown are for inlet LwA sound power levels for Installation Type B: Free inlet, ducted outlet.
6. Ratings do not include the effects of duct end correction.
7. The A-weighted sound ratings shown have been calculated per AMCA Standard 301.

BAE-DW 807

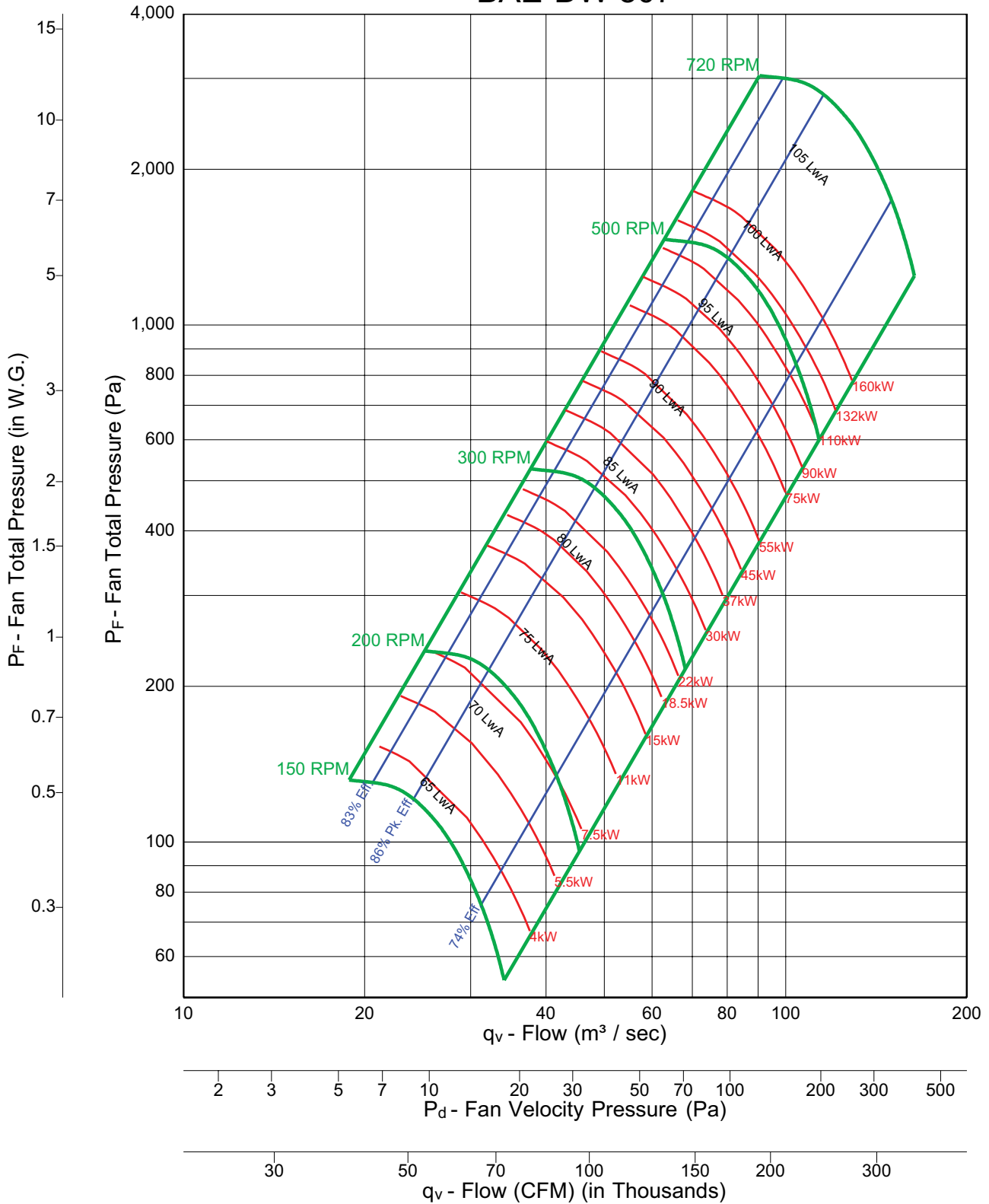

Fan Efficiency Grade = FEG 90



Notes:

1. Performance certified is for Installation Type B & D: Free or ducted inlet, ducted outlet.
2. Power rating (kW) does not include transmission losses.
3. Performance ratings do not include the effects of appurtenances (accessories).
4. The sound power level ratings shown are in decibels, referred to 10 E-12 watts calculated per AMCA Standard 301.
5. Values shown are for inlet LwA sound power levels for Installation Type B: Free inlet, ducted outlet.
6. Ratings do not include the effects of duct end correction.
7. The A-weighted sound ratings shown have been calculated per AMCA Standard 301.

BAE-DW 890

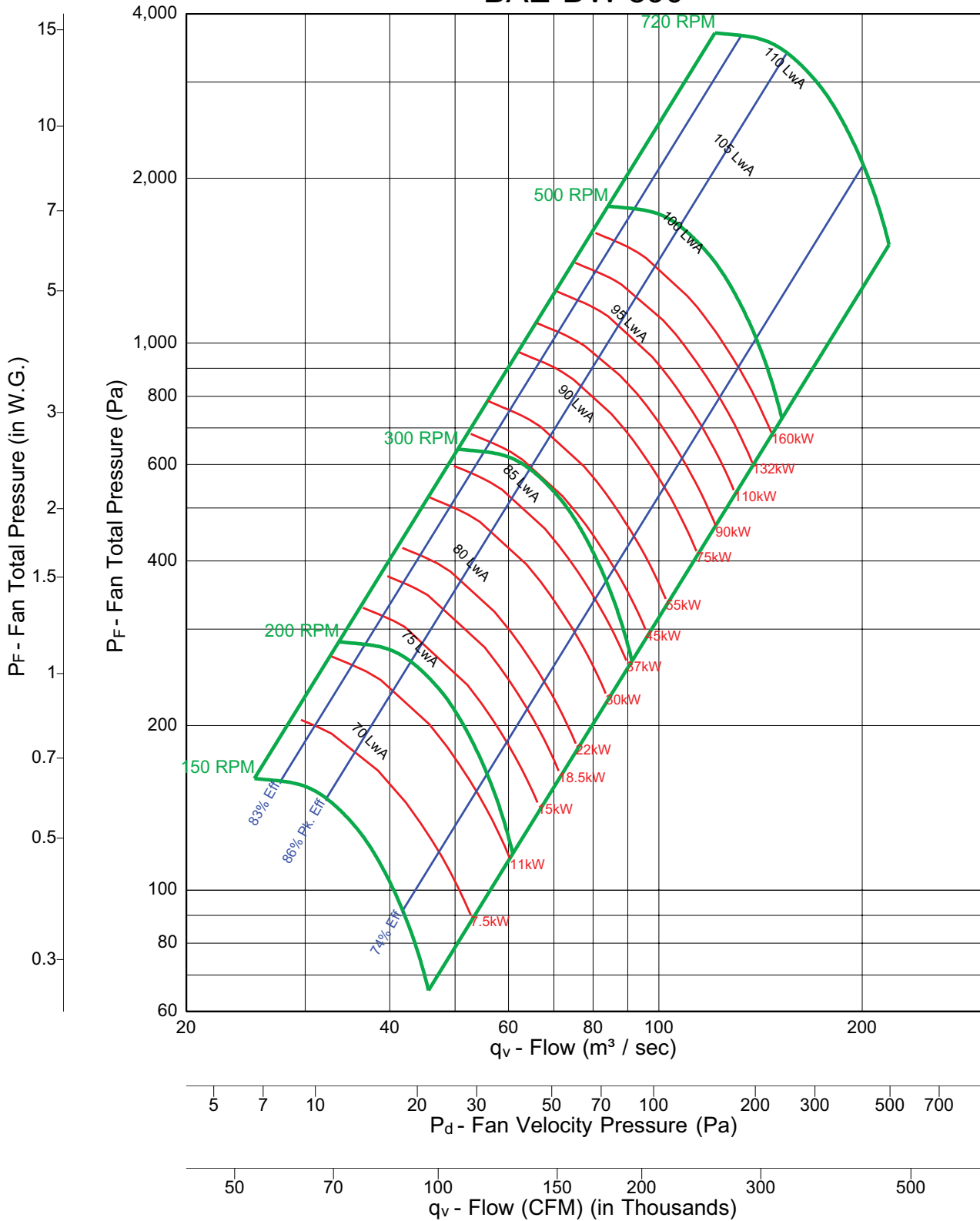

Fan Efficiency Grade = FEG 90



Notes:

1. Performance certified is for Installation Type B & D: Free or ducted inlet, ducted outlet.
2. Power rating (kW) does not include transmission losses.
3. Performance ratings do not include the effects of appurtenances (accessories).
4. The sound power level ratings shown are in decibels, referred to 10 E-12 watts calculated per AMCA Standard 301.
5. Values shown are for inlet LwA sound power levels for Installation Type B: Free inlet, ducted outlet.
6. Ratings do not include the effects of duct end correction.
7. The A-weighted sound ratings shown have been calculated per AMCA Standard 301.

BAE-DW 982

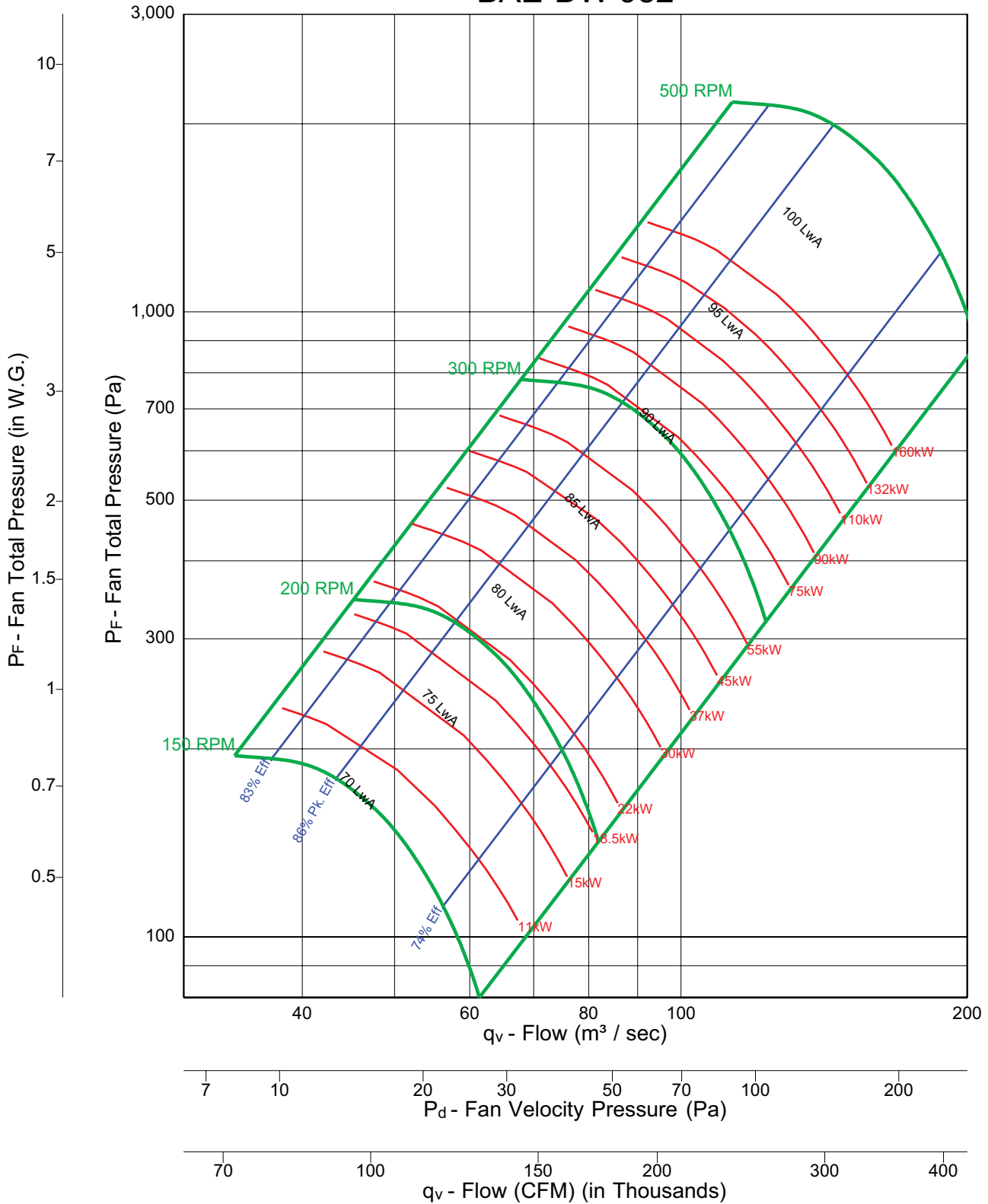

Fan Efficiency Grade = FEG 90



Notes:

1. Performance certified is for Installation Type B & D: Free or ducted inlet, ducted outlet.
2. Power rating (kW) does not include transmission losses.
3. Performance ratings do not include the effects of appurtenances (accessories).
4. The sound power level ratings shown are in decibels, referred to 10 E-12 watts calculated per AMCA Standard 301.
5. Values shown are for inlet LwA sound power levels for Installation Type B: Free inlet, ducted outlet.
6. Ratings do not include the effects of duct end correction.
7. The A-weighted sound ratings shown have been calculated per AMCA Standard 301.

Arrangement 9, SWSI Rotatable, Class I & II

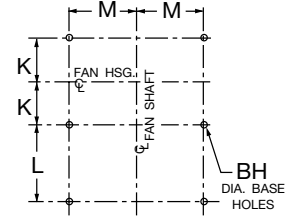
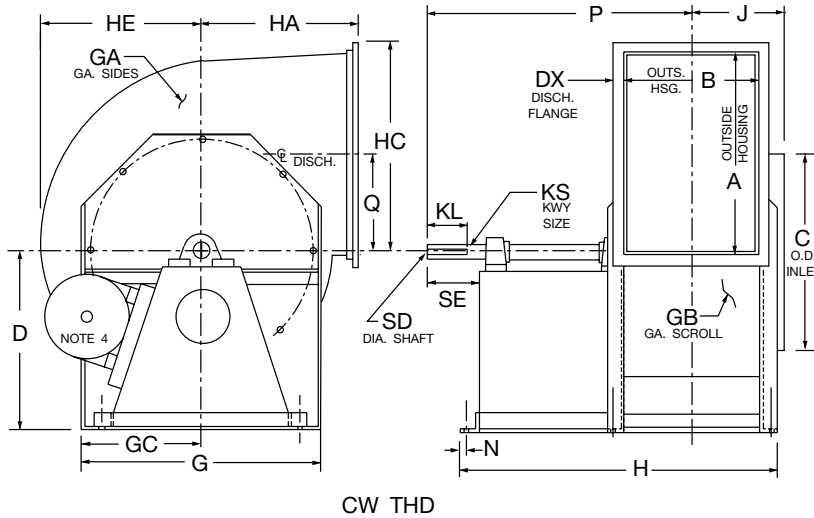

FOUNDATION PLAN

CW THD

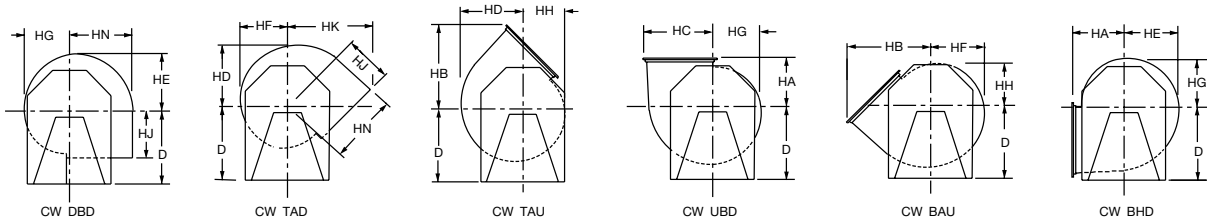

NOTES:

1. Discharge angles are included on all discharges except "TAD" and "DBD."
2. "CW" rotation is shown. "CCW" rotation is similar but opposite.
- *3. Shaft diameter is increased to 1.187 on Hi-Temp. fans which require shaft coolers.
4. Standard Arr. 9 motor location is on the left for "CW" rotation units and on the right for "CCW" rotation. Dimension "FR" equals max. motor frame.

SIZE	A	B	BH	C	D	DX	FR	G	GA	GB	GC	H	HA	HB	HC	HD	HE	HF
122	330	248	11	337	368	25	90L	406	2.0	2.0	203	686	248	425	354	284	268	252
135	363	275	11	370	400	25	112M	445	2.0	2.0	222	778	273	467	387	313	295	278
150	403	303	11	411	451	25	112M	483	2.0	2.0	241	806	303	516	427	349	327	308
165	443	335	11	451	483	25	132M	521	2.0	2.0	260	918	334	565	467	383	359	338
182	492	370	11	495	533	32	160M	572	2.5	2.0	286	1064	368	630	522	424	399	375
200	538	405	14	543	578	32	160M	635	2.5	2.0	318	1099	402	686	568	467	440	413
222	598	449	14	603	648	32	160L	692	2.5	2.0	346	1149	449	762	629	519	484	456
245	659	494	14	662	711	32	160L	756	2.5	2.0	378	1194	495	838	689	568	533	502
270	727	543	14	724	775	38	180M	838	2.5	2.0	419	1314	545	926	764	627	589	554

SIZE	HG	HH	HJ	HK	HN	J	K	KL	KS		L	M	N	P	Q	SD		SE
									CLASS I	CLASS II						CLASS I	CLASS II	
122	236	221	235	399	329	189	146	64	8 x 7	8 x 7	368	171	13	572	164	25	25*	83
135	260	243	260	440	362	203	160	64	8 x 7	8 x 7	432	187	13	649	181	25	25*	83
150	289	270	291	489	402	230	175	76	8 x 7	8 x 7	432	210	13	676	200	25	30	95
165	318	297	321	538	441	246	191	76	8 x 7	8 x 7	505	222	16	756	221	25*	30	95
182	351	327	356	598	490	276	208	89	8 x 7	10 x 8	616	245	16	897	245	30	38	108
200	404	359	389	654	537	294	226	89	10 x 8	10 x 8	616	270	16	914	268	38	38	108
222	427	399	437	730	597	316	254	102	10 x 8	10 x 8	597	298	22	943	298	38	38	121
245	470	438	483	806	657	338	276	114	10 x 8	14 x 9	597	327	22	978	329	38	45	133
270	519	484	532	889	725	362	300	114	14 x 9	14 x 9	670	359	22	1075	362	45	45	133

DIMENSIONS ARE NOT TO BE USED FOR CONSTRUCTION. CERTIFIED DRAWINGS AVAILABLE UPON REQUEST.

Arrangement 1 & 9, SWSI Non-Rotatable, Class I & II

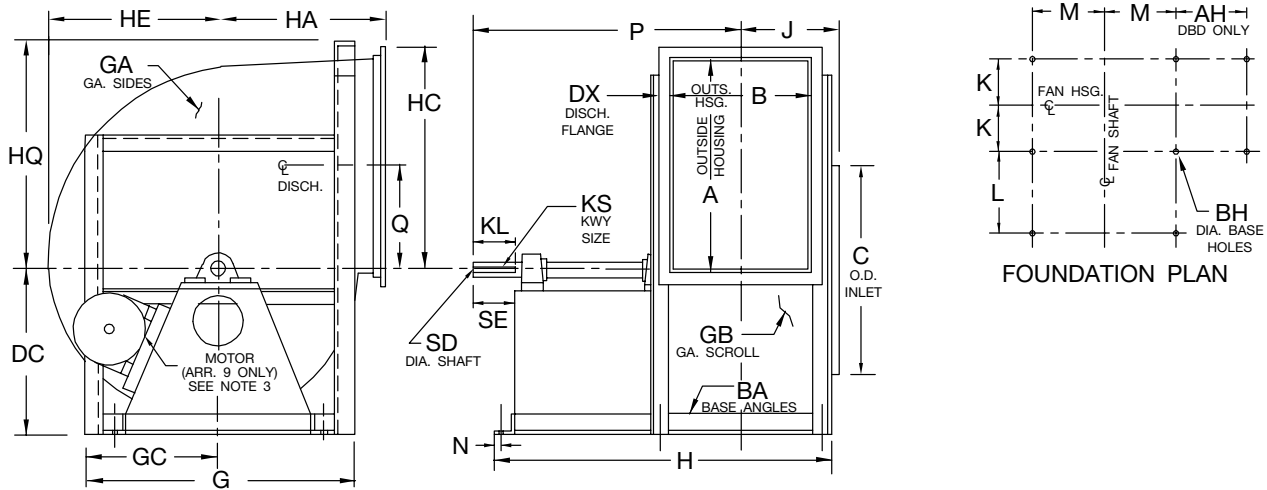

CW THD

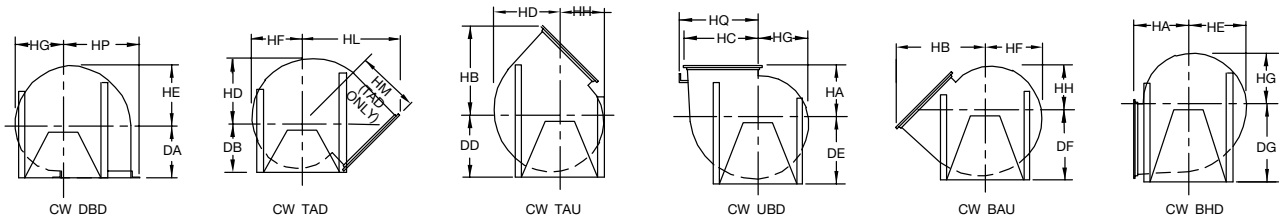

NOTES:

1. Discharge angles are included on all discharges.
2. "CW" rotation is shown. "CCW" rotation is similar but opposite.
3. Standard Arr. 9 motor location is on the left for "CW" rotation units and on the right for "CCW" rotation. Dimension "FR" equals max. motor frame.
4. For fans with inlet box at 90 degrees or 270 degrees, use "BAU" discharge dimension "DF" for centerline height.

SIZE	A	AH	B	BA	BH	C	DA	DB	DC	DD	DE	DF	DG	DX	FR ARR. 9	G	GA	GB
300	808	438	605	65 x 65	14	803	679	679	679	679	724	762	902	38	180L	1041	3.0	2.5
330	892	484	662	65 x 65	14	883	762	762	762	762	787	832	991	38	200M	1118	3.0	2.5
365	983	537	734	65 x 65	14	978	737	775	749	800	851	902	1041	38	200M	1219	3.0	2.5
402	1083	592	808	75 x 75	21	1078	813	826	838	895	940	1003	1156	38	200L	1334	3.0	2.5
445	1197	656	894	75 x 75	21	1191	899	921	902	978	1016	1099	1270	38	225S	1435	3.0	2.5
490	1319	715	981	75 x 75	21	1311	991	984	991	1073	1118	1207	1391	51	225S	1562	3.0	2.5
542	1457	808	1089	75 x 100	21	1451	1094	1073	1105	1181	1245	1327	1530	51	250S	1702	3.0	2.5
600	1613	887	1202	75 x 100	21	1604	1211	1143	1219	1302	1372	1461	1683	51	250S	1854	3.0	2.5
660	1770	994	1326	90 x 125	21	1762	1332	1257	1334	1416	1499	1600	1861	64	250M	2032	3.0	2.5
730	1962	1083	1462	90 x 125	21	1949	1473	1378	1448	1568	1638	1765	2051	64	250M	2235	3.0	3.0

SIZE	GC	H	HA	HB	HC	HD	HE	HF	HG	HH	HL	HM	HP	HQ	J	K	KL	KS	
																		CL I	CL II
300	521	1416	605	1024	845	697	654	616	578	540	1197	849	870	—	394	338	127	14 x 9	14 x 9
330	559	1540	667	1129	929	765	721	678	635	592	1295	903	954	—	422	367	127	14 x 9	16 x 10
365	610	1610	737	1242	1019	851	800	753	705	657	1410	975	1045	—	457	402	127	14 x 9	18 x 11
402	667	1724	813	1367	1119	940	881	829	776	724	1537	1056	1157	—	508	446	127	16 x 10	18 x 11
445	718	1851	899	1508	1233	1038	972	914	857	800	1669	1127	1272	—	551	489	140	18 x 11	20 x 12
490	781	1946	991	1669	1369	1140	1072	1008	945	881	1837	1230	1394	—	594	532	140	20 x 12	20 x 12
542	851	2223	1094	1838	1506	1264	1186	1116	1046	976	2004	1329	1557	1518	673	598	152	20 x 12	25 x 14
600	927	2330	1211	2032	1662	1397	1313	1235	1157	1080	2191	1437	1713	1670	730	656	152	20 x 12	25 x 14
660	1016	2572	1332	2237	1832	1534	1443	1356	1268	1181	2408	1575	1896	1835	818	730	178	25 x 14	28 x 16
730	1118	2785	1473	2472	2023	1700	1597	1502	1407	1311	2646	1719	2086	2026	887	799	191	25 x 14	28 x 16

DIMENSIONS ARE NOT TO BE USED FOR CONSTRUCTION. CERTIFIED DRAWINGS AVAILABLE UPON REQUEST.

Arrangement 1 & 9, Non-Rotatable, Class I & II (cont'd.)

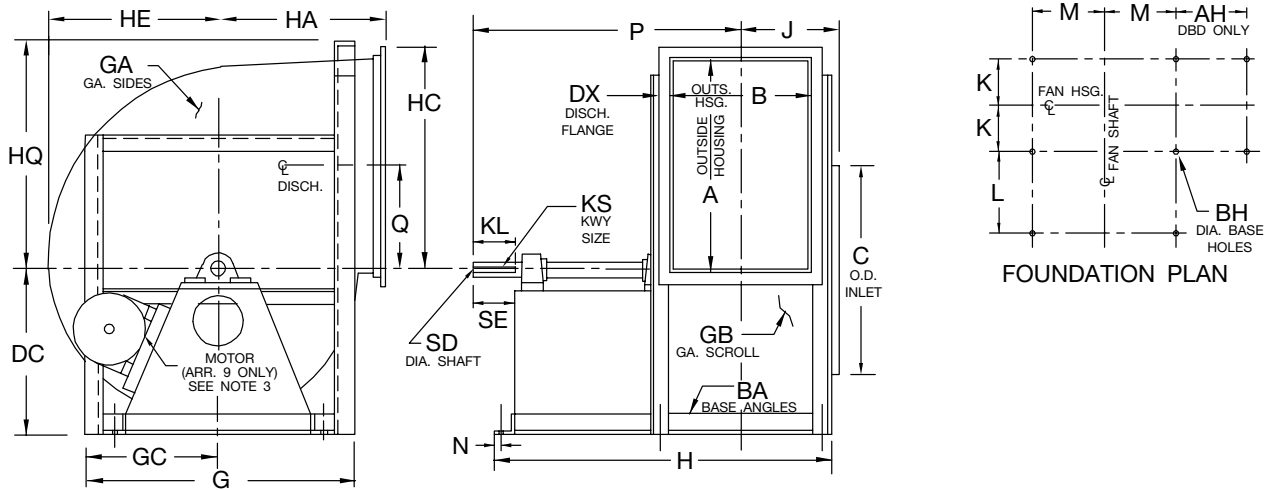

CW THD

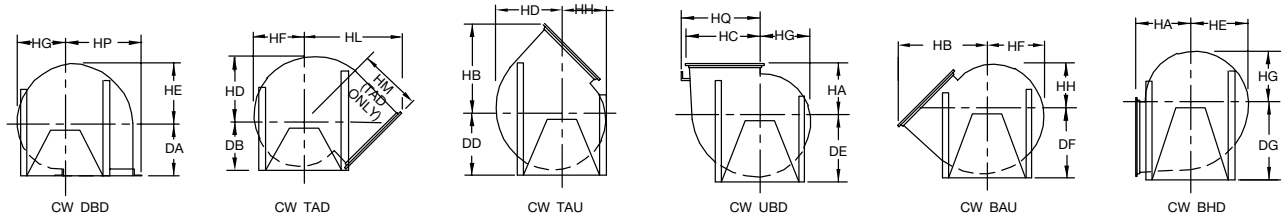

NOTES:

1. Discharge angles are included on all discharges.
2. "CW" rotation is shown. "CCW" rotation is similar but opposite.
3. Standard Arr. 9 motor location is on the left for "CW" rotation units and on the right for "CCW" rotation. Dimension "FR" equals max. motor frame.
4. For fans with inlet box at 90 degrees or 270 degrees, use "BAU" discharge dimension "DF" for centerline height.

SIZE	L	M	N	P	Q	SD		SE
						CL I	CL II	
300	683	403	29	1132	402	50	50	146
330	749	441	29	1227	445	50	55	146
365	749	480	29	1262	489	50	65	146
402	762	530	35	1313	540	55	65	146
445	803	581	35	1410	597	65	70	159
490	813	645	35	1462	657	70	75	159
542	930	702	48	1646	727	75	90	171
600	924	778	48	1697	805	75	90	171
660	991	842	60	1851	883	90	100	197
730	1067	943	60	2008	978	90	100	210

DIMENSIONS ARE NOT TO BE USED FOR CONSTRUCTION. CERTIFIED DRAWINGS AVAILABLE UPON REQUEST.

Arrangement 1, SWSI Non-Rotatable, Class I & II

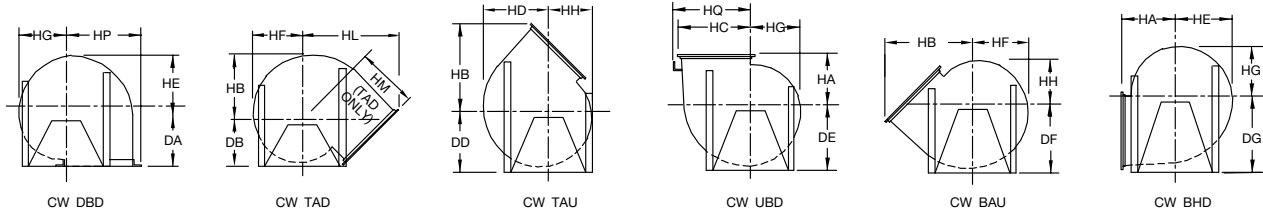
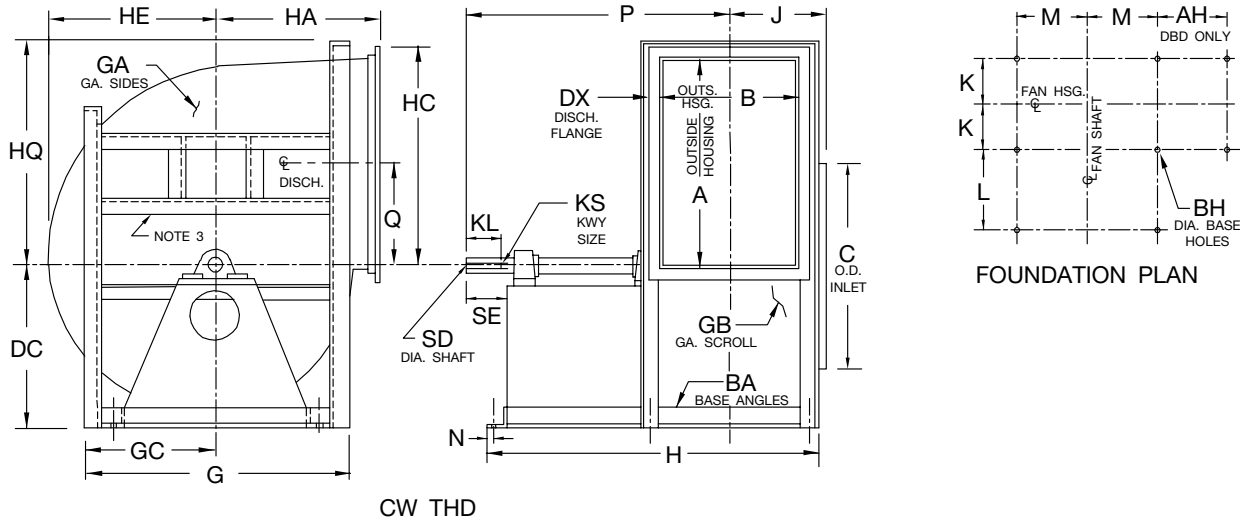

NOTES:

1. Discharge angles are included on all discharges.
2. "CW" rotation is shown. "CCW" rotation is similar but opposite.
3. Frame supports vary in construction by size and by discharge position.
4. For fans with inlet box at 90 degrees or 270 degrees, use "BAU" discharge dimension "DF" for centerline height.

SIZE	A	AH	B	BA	BH	C	DA	DB	DC	DD	DE	DF	DG	DX	G	GA	GB	GC
807	2170	1195	1616	90 x 125	21	2156	1630	1511	1600	1715	1829	1943	2261	64	2426	3	3	1213
890	2391	1276	1781	90 x 125	21	2372	1778	1664	1759	1873	1988	2159	2483	64	2705	5	3	1353
982	2642	1365	1969	125 x 150	21	2629	1975	1816	1943	2032	2197	2337	2750	64	3099	5	5	1549

SIZE	H	HA	HB	HC	HD	HE	HF	HG	HH	HL	HM	HP	HQ	J	K	KL	KS	
																	CL I	CL II
807	3013	1630	2731	2230	1880	1765	1661	1556	1451	2888	1854	2294	2229	960	875	203	28 x 16	32 x 18
890	3255	1778	2991	2451	2072	1946	1830	1715	1599	3185	2051	2515	2451	1043	957	203	28 x 16	32 x 18
982	3572	1975	3305	2700	2288	2150	2021	1892	1764	3558	2330	2788	2711	1162	1064	203	32 x 18	enq

SIZE	L	M	N	P	Q	SD		SE
						CL I	CL II	
807	1143	1038	60	2180	1083	100	115	229
890	1219	1178	60	2338	1192	100	125	229
982	1299	1350	73	2512	1316	125	enq	229

Arrangement 3, SWSI Non-Rotatable, Class I & II

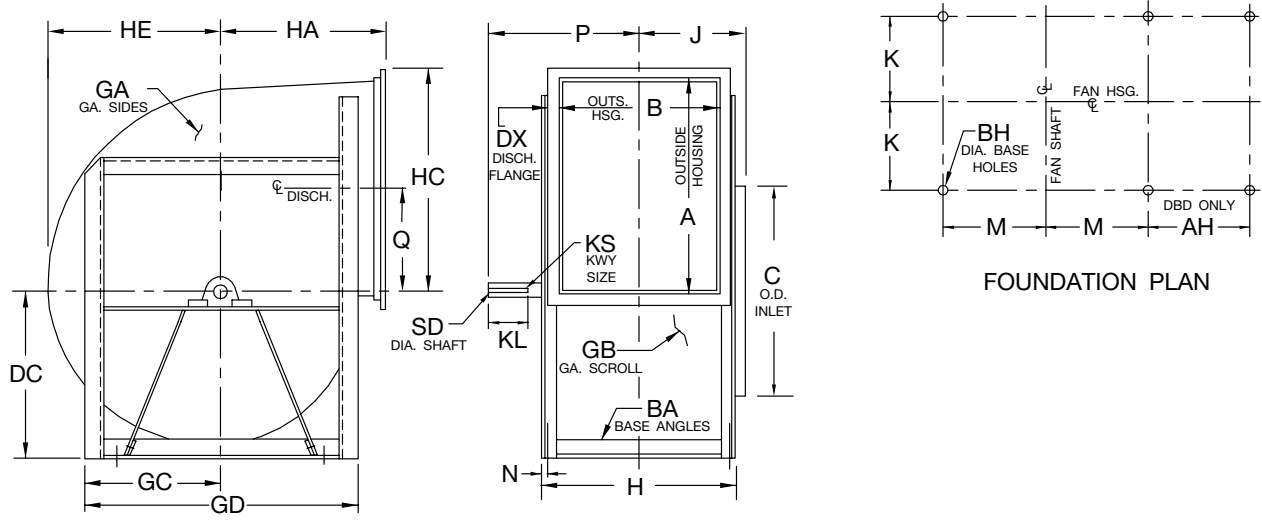

CW THD

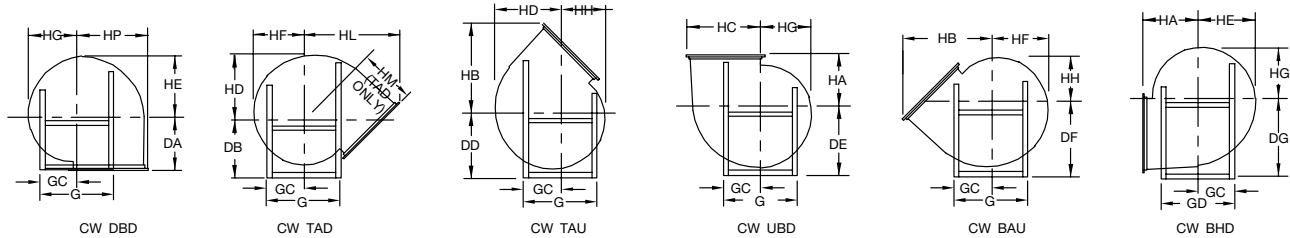

NOTES:

1. Discharge angles are included on all discharges.
2. Inlet bearing bar support is removable.
3. "CW" rotation is shown. "CCW" rotation is similar but opposite.
4. Bearing bar supports may extend beyond base angles. See Drawing AC1000851 for dimensions if space limitations are required for mounting fan.

SIZE	A	AH	B	BA	BH	C	DA	DB	DC	DD	DE	DF	DG	DX	G	GA	GB	GC
122	330	179	248	38 x 38	11	337	248	387	260	279	292	311	381	25	502	2.0	2.0	251
135	363	197	275	38 x 38	11	370	273	406	286	305	324	337	413	25	533	2.0	2.0	267
150	403	214	303	38 x 38	11	411	303	425	311	337	356	375	457	25	578	2.0	2.0	289
165	443	248	335	38 x 50	11	451	334	445	343	368	387	413	495	25	616	2.0	2.0	308
182	492	275	370	38 x 50	11	495	368	470	375	400	425	451	546	32	660	2.5	2.0	330
200	538	295	405	38 x 50	14	543	402	495	413	438	464	489	597	32	711	2.5	2.0	356
222	598	327	449	50 x 50	14	603	449	533	457	489	521	559	660	32	794	2.5	2.0	397
245	659	359	494	50 x 50	14	662	495	559	508	540	572	610	718	32	851	2.5	2.0	425
270	727	395	543	50 x 50	14	724	545	597	559	597	629	667	787	38	914	2.5	2.0	457

SIZE	GD	H	HA	HB	HC	HD	HE	HF	HG	HH	HL	HM	HP	J	K	KL	KS	
																	CLASS I	CLASS II
122	470	324	248	425	354	284	268	252	236	221	572	454	367	189	146	64	8 x 7	8 x 7
135	502	353	273	467	387	313	295	278	260	243	611	476	400	203	160	64	8 x 7	8 x 7
150	546	381	303	516	427	349	327	308	289	270	660	508	440	230	175	76	8 x 7	8 x 7
165	616	438	334	565	467	383	359	338	318	297	708	535	492	246	197	76	8 x 7	8 x 7
182	660	473	368	630	522	424	399	375	351	327	773	572	541	276	214	89	8 x 7	10 x 8
200	711	508	402	686	568	467	440	413	386	359	832	608	588	294	232	89	10 x 8	10 x 8
222	794	552	449	762	629	519	484	456	427	399	916	667	648	316	254	102	10 x 8	10 x 8
245	851	597	495	838	689	568	533	502	470	438	988	706	708	338	276	114	10 x 8	14 x 9
270	914	645	545	926	764	627	589	554	519	484	1076	759	776	362	300	114	10 x 8	14 x 9

DIMENSIONS ARE NOT TO BE USED FOR CONSTRUCTION. CERTIFIED DRAWINGS AVAILABLE UPON REQUEST.

Arrangement 3, SWSI Non-Rotatable, Class I & II (cont'd.)

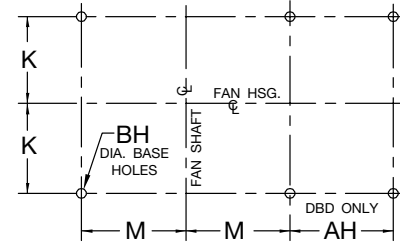
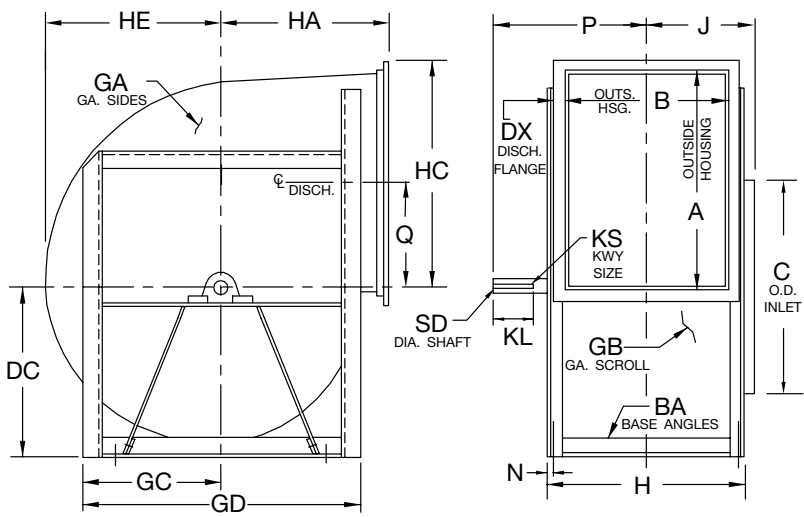

FOUNDATION PLAN

CW THD

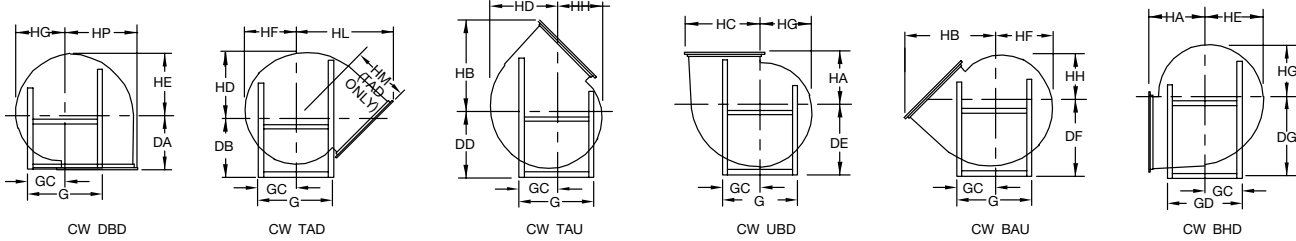

NOTES:

1. Discharge angles are included on all discharges.
2. Inlet bearing bar support is removable.
3. "CW" rotation is shown. "CCW" rotation is similar but opposite.
4. Bearing bar supports may extend beyond base angles. See Drawing AC1000851 for dimensions if space limitations are required for mounting fan.

SIZE	M	N	P		Q	SD	
			CL I	CL II		CL I	CL II
122	171	16	254	254	164	25	25
135	187	16	268	268	181	25	25
150	210	16	295	305	200	25	30
165	222	22	311	321	221	25	30
182	245	22	351	372	245	30	38
200	270	22	389	389	268	38	38
222	298	22	424	424	298	38	38
245	327	22	459	468	329	38	45
270	359	22	483	492	362	38	45

DIMENSIONS ARE NOT TO BE USED FOR CONSTRUCTION. CERTIFIED DRAWINGS AVAILABLE UPON REQUEST.

Arrangement 3, SWSI Non-Rotatable, Class I & II

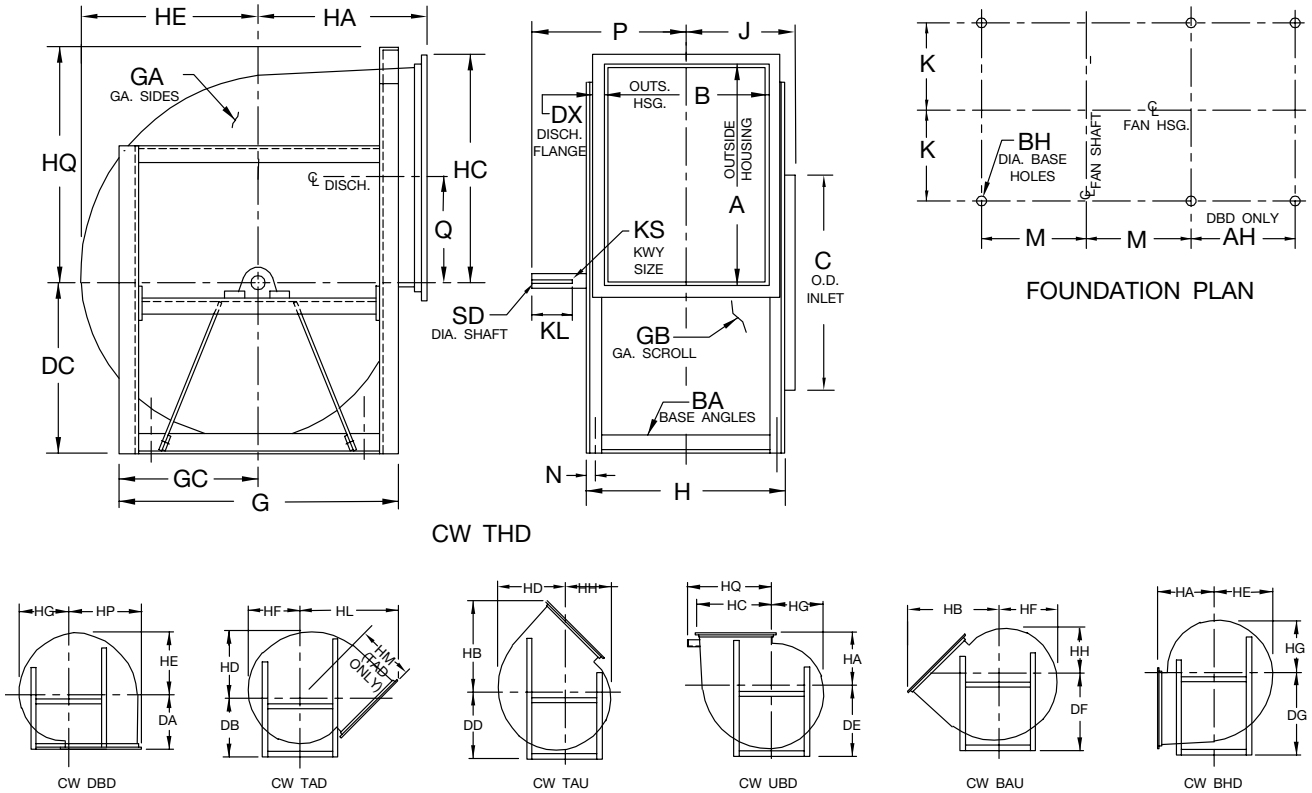

CW THD

NOTES:

1. Discharge angles are included on all discharges.
2. Inlet bearing bar support is removable.
3. "CW" rotation is shown. "CCW" rotation is similar but opposite.
4. Frame supports vary in construction by size and by discharge position.
5. Bearing bar supports may extend beyond base angles. See Drawing AC1000851 for dimensions if space limitations are required for mounting fan.

SIZE	A	AH	B	BA	BH	C	DA	DB	DC	DD	DE	DF	DG	DX	G	GA	GB	GC
300	808	438	605	65 x 65	14	803	605	660	622	660	724	749	870	38	1041	3.0	2.5	521
330	892	484	662	65 x 65	14	883	667	705	686	724	787	819	946	38	1118	3.0	2.5	559
365	983	537	734	65 x 65	14	978	737	775	749	800	851	902	1041	38	1219	3.0	2.5	610
402	1083	592	808	75 x 75	21	1078	813	826	838	895	940	1003	1156	38	1334	3.0	2.5	667
445	1197	656	894	75 x 75	21	1191	899	921	902	978	1016	1099	1270	38	1435	3.0	2.5	718
490	1319	715	981	75 x 75	21	1311	991	984	991	1073	1118	1207	1391	51	1562	3.0	2.5	781
542	1457	808	1089	75 x 100	21	1451	1094	1073	1105	1181	1245	1327	1530	51	1702	3.0	2.5	851
600	1613	887	1202	75 x 100	21	1604	1211	1143	1219	1302	1372	1461	1683	51	1854	3.0	2.5	927
660	1770	994	1326	90 x 125	21	1762	1332	1257	1334	1416	1499	1600	1861	64	2032	3.0	2.5	1016
730	1962	1083	1462	90 x 125	21	1949	1473	1378	1448	1568	1638	1765	2051	64	2235	3.0	3.0	1118

SIZE	H	HA	HB	HC	HD	HE	HF	HG	HH	HL	HM	HP	HQ	J	K	KL	KS	
																	CLASS I	CLASS II
300	734	605	1024	845	697	654	616	578	540	1197	849	870	—	406	338	127	14 x 9	14 x 9
330	791	667	1129	929	765	721	678	635	592	1295	903	954	—	435	367	127	14 x 9	16 x 10
365	861	737	1242	1019	851	800	753	705	657	1410	975	1045	—	484	402	127	14 x 9	18 x 11
402	962	813	1367	1119	940	881	829	776	724	1537	1056	1157	—	521	446	127	14 x 9	18 x 11
445	1048	899	1508	1233	1038	972	914	857	800	1666	1127	1272	—	576	489	140	14 x 9	20 x 12
490	1134	991	1669	1369	1140	1072	1008	945	881	1837	1230	1394	—	621	532	140	16 x 10	20 x 12
542	1292	1094	1838	1506	1264	1186	1116	1046	976	2004	1329	1557	1518	675	598	152	18 x 11	20 x 12
600	1407	1211	2032	1662	1397	1313	1235	1157	1080	2191	1437	1713	1670	730	656	152	20 x 12	25 x 14
660	1581	1332	2237	1832	1534	1443	1356	1268	1181	2408	1575	1896	1835	818	730	178	20 x 12	28 x 16
730	1718	1473	2472	2023	1700	1597	1502	1407	1311	2646	1719	2086	2026	886	799	191	25 x 14	28 x 16

DIMENSIONS ARE NOT TO BE USED FOR CONSTRUCTION. CERTIFIED DRAWINGS AVAILABLE UPON REQUEST.

Arrangement 3, SWSI Non-Rotatable, Class I & II

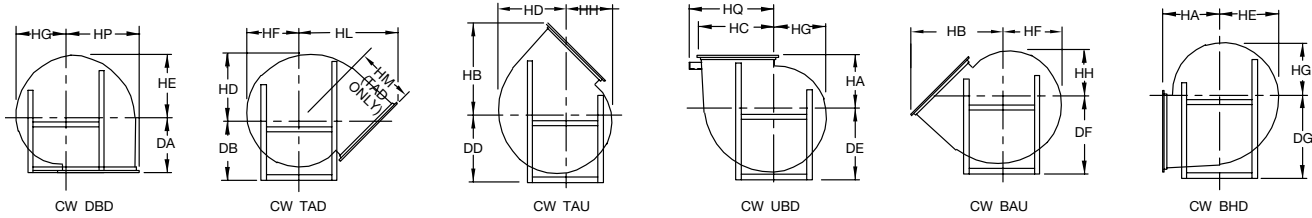
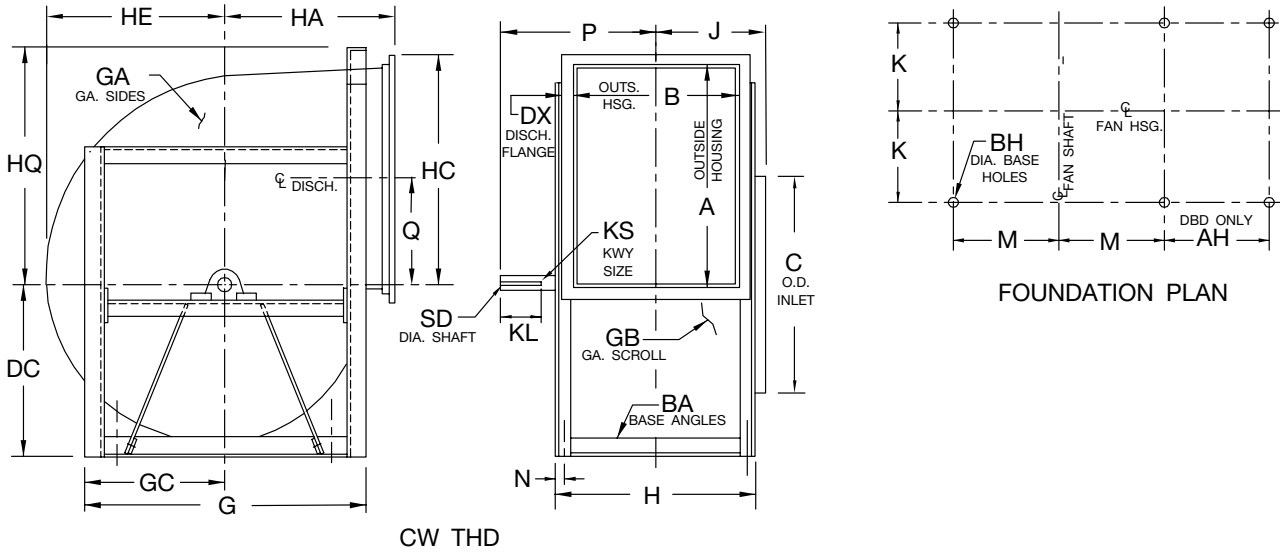

NOTES:

1. Discharge angles are included on all discharges.
2. Inlet bearing bar support is removable.
3. "CW" rotation is shown. "CCW" rotation is similar but opposite.
4. Frame supports vary in construction by size and by discharge position.
5. Bearing bar supports may extend beyond base angles. See Drawing AC1000851 for dimensions if space limitations are required for mounting fan.

SIZE	M	N	P		Q	SD	
			CL I	CL II		CL I	CL II
300	403	29	537	540	402	45	50
330	441	29	565	581	445	45	55
365	480	29	603	626	489	50	65
402	530	35	641	664	540	50	65
445	581	35	697	741	597	50	70
490	645	35	768	784	657	55	70
542	702	48	848	857	727	65	75
600	778	48	902	937	805	75	90
660	842	60	1013	1037	883	75	100
730	943	60	1105	1118	978	90	100

DIMENSIONS ARE NOT TO BE USED FOR CONSTRUCTION. CERTIFIED DRAWINGS AVAILABLE UPON REQUEST.

Arrangement 3, SWSI Non-Rotatable, Class I & II

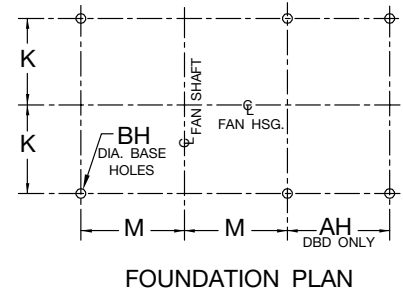
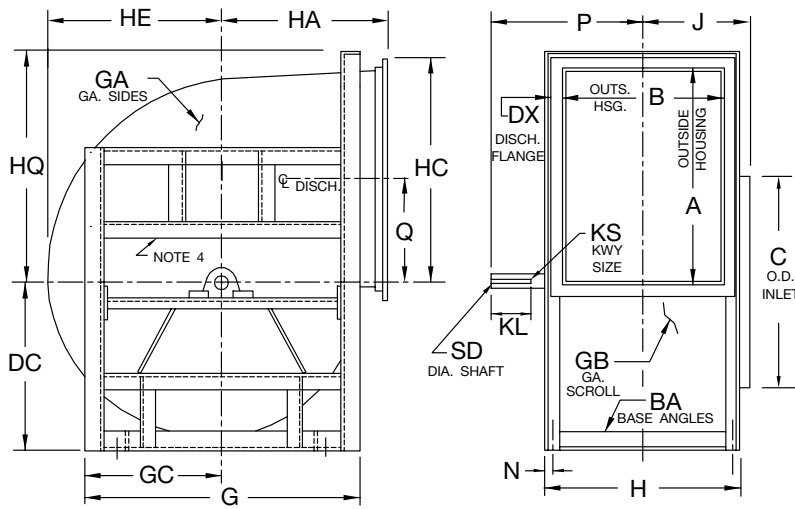

CW THD

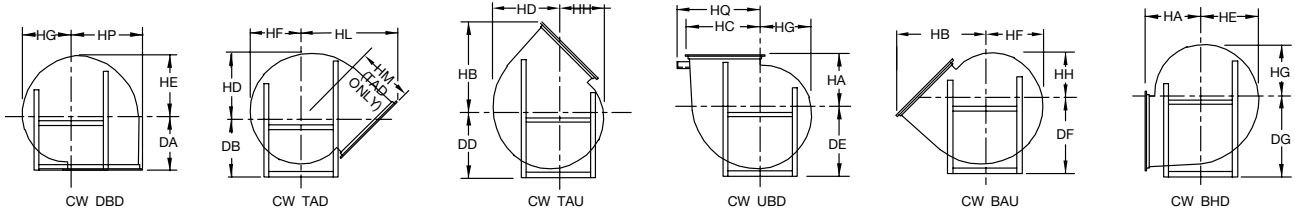

NOTES:

1. Discharge angles are included on all discharges.
2. Inlet bearing bar support is removable.
3. "CW" rotation is shown. "CCW" rotation is similar but opposite.
4. Frame supports vary in construction by size and by discharge position.
5. Bearing bar supports may extend beyond base angles. See Drawing AC1000851 for dimensions if space limitations are required for mounting fan.

SIZE	A	AH	B	BA	BH	C	DA	DB	DC	DD	DE	DF	DG	DX	G	GA	GB	GC
807	2170	1195	1616	90 x 125	21	2156	1630	1511	1600	1715	1829	1943	2261	64	2426	3	3	1213
890	2391	1276	1781	90 x 125	21	2372	1778	1664	1759	1873	1988	2159	2484	64	2705	5	3	1353
982	2642	1365	1969	100 x 150	21	2629	1975	1816	1943	2032	2197	2337	2750	64	3099	5	5	1549

SIZE	H	HA	HB	HC	HD	HE	HF	HG	HH	HL	HM	HP	HQ	J	K	KL	KS	
																	CL I	CL II
807	1870	1630	2731	2230	1880	1765	1661	1556	1451	2888	1854	2294	2229	988	875	203	28 x 16	32 x 18
890	2035	1778	2991	2451	2072	1946	1830	1715	1599	3185	2051	2515	2451	1097	957	203	28 x 16	32 x 18
982	2273	1975	3305	2700	2288	2150	2021	1892	1764	3558	2330	2788	2711	1216	1064	203	32 x 18	enq

SIZE	M	N	P		Q	SD	
			CL I	CL II		CL I	CL II
807	1038	60	1210	1259	1083	100	115
890	1178	60	1289	1357	1192	100	125
982	1350	73	1445	1470	1316	125	enq

DIMENSIONS ARE NOT TO BE USED FOR CONSTRUCTION. CERTIFIED DRAWINGS AVAILABLE UPON REQUEST.

Arrangement 1, SWSI Non-Rotatable, Class III

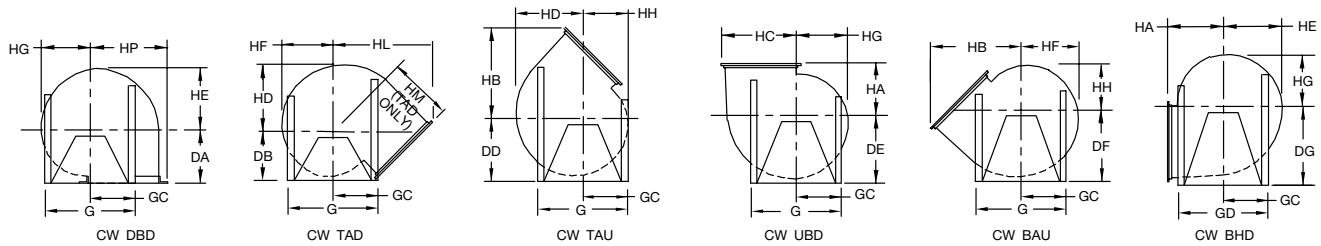
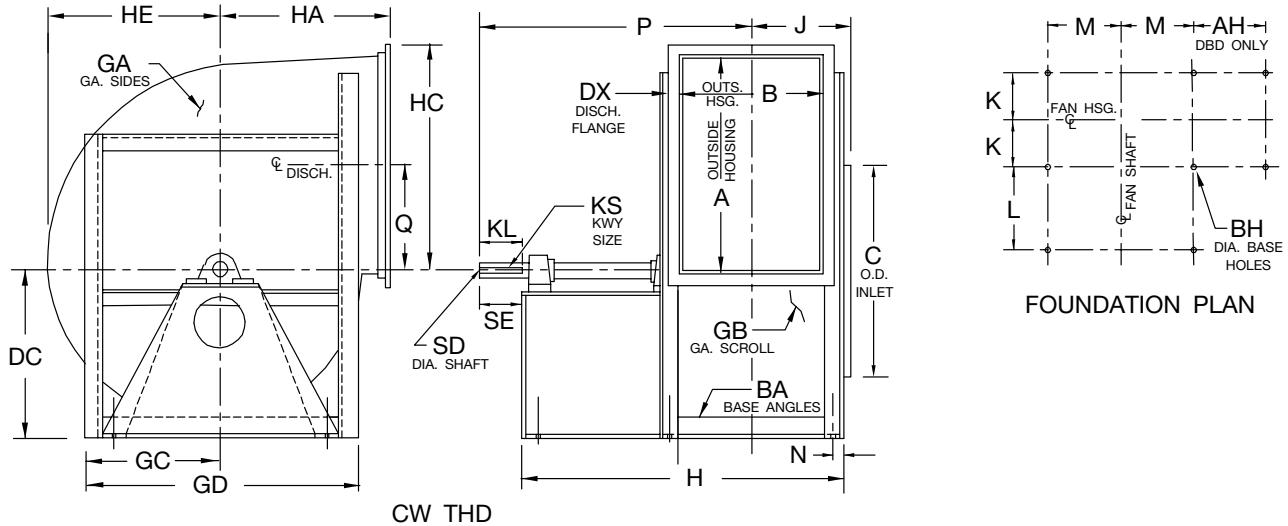

- NOTES:**
1. Discharge angles are included on all discharges.
 2. "CW" rotation is shown. "CCW" rotation is similar but opposite.
 3. For fans size 182-330 (except TAD 182-200) with inlet box at 90 degrees or 270 degrees, use "BAU" discharge dimension "DF" for centerline height.

SIZE	A	AH	B	BA	BH	C	DA	DB	DC	DD	DE	DF	DG	DX	G	GA	GB	GC
122	334	194	251	38 x 50	11	337	248	387	260	279	292	311	394	32	502	3	3	251
135	367	211	278	38 x 50	11	370	273	406	286	305	324	337	425	32	533	3	3	267
150	406	229	306	38 x 50	11	411	303	425	311	337	356	375	470	32	578	3	3	289
165	446	249	338	38 x 50	11	451	334	445	343	368	387	413	495	32	616	3	3	308
182	495	276	372	50 x 50	14	495	368	470	375	400	425	451	559	32	686	3	3	343
200	541	297	406	50 x 50	14	543	402	495	413	438	464	489	610	32	737	3	3	368
222	602	341	451	65 x 65	14	603	449	533	457	489	521	559	673	32	819	3	3	410
245	665	372	499	65 x 65	14	662	495	559	508	540	572	610	730	38	876	5	5	438
270	734	411	548	65 x 65	14	724	545	597	559	597	629	667	800	38	940	5	5	470
300	813	452	608	75 x 75	21	803	605	660	622	660	699	749	883	38	1067	5	5	533
330	897	499	665	75 x 75	21	883	667	705	686	724	762	819	959	38	1143	5	5	572

SIZE	GD	H	HA	HB	HC	HD	HE	HF	HG	HH	HL	HM	HP	J	K	KL	KS
122	473	568	248	432	362	286	270	254	238	222	583	462	381	202	154	76	10 x 8
135	505	610	273	473	395	314	297	279	262	245	622	484	414	216	168	76	10 x 8
150	549	676	303	522	435	351	329	310	291	272	673	516	454	230	183	89	14 x 9
165	588	708	334	572	475	384	360	340	319	298	719	543	494	246	198	89	14 x 9
182	686	765	368	630	524	425	400	376	353	329	789	592	543	262	214	114	14 x 9
200	737	826	402	687	570	467	441	414	387	360	846	627	589	279	232	114	14 x 9
222	819	946	449	764	630	521	486	457	429	400	932	687	662	314	260	127	14 x 9
245	876	1032	495	845	699	572	537	505	473	441	988	699	724	338	284	152	18 x 11
270	940	1134	545	927	767	630	592	557	522	487	1068	743	792	363	310	152	18 x 11
300	1067	1257	605	1026	846	699	656	617	579	537	1187	833	884	406	346	178	18 x 11
330	1143	1365	667	1129	930	767	722	679	637	594	1286	887	969	435	375	178	20 x 12

DIMENSIONS ARE NOT TO BE USED FOR CONSTRUCTION. CERTIFIED DRAWINGS AVAILABLE UPON REQUEST.

Arrangement 1, SWSI Non-Rotatable, Class III (cont'd.)

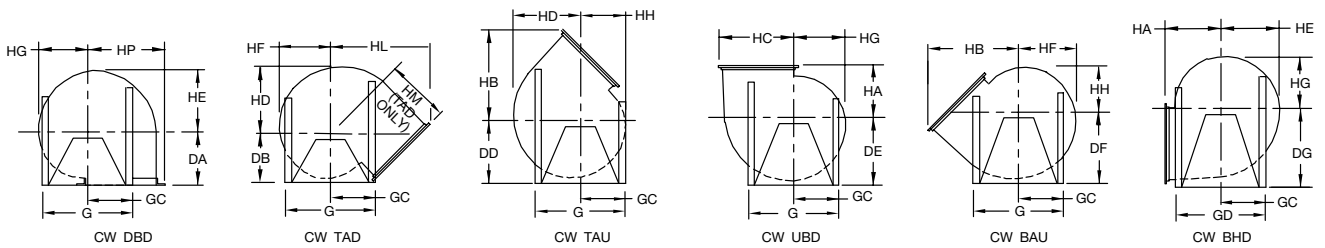
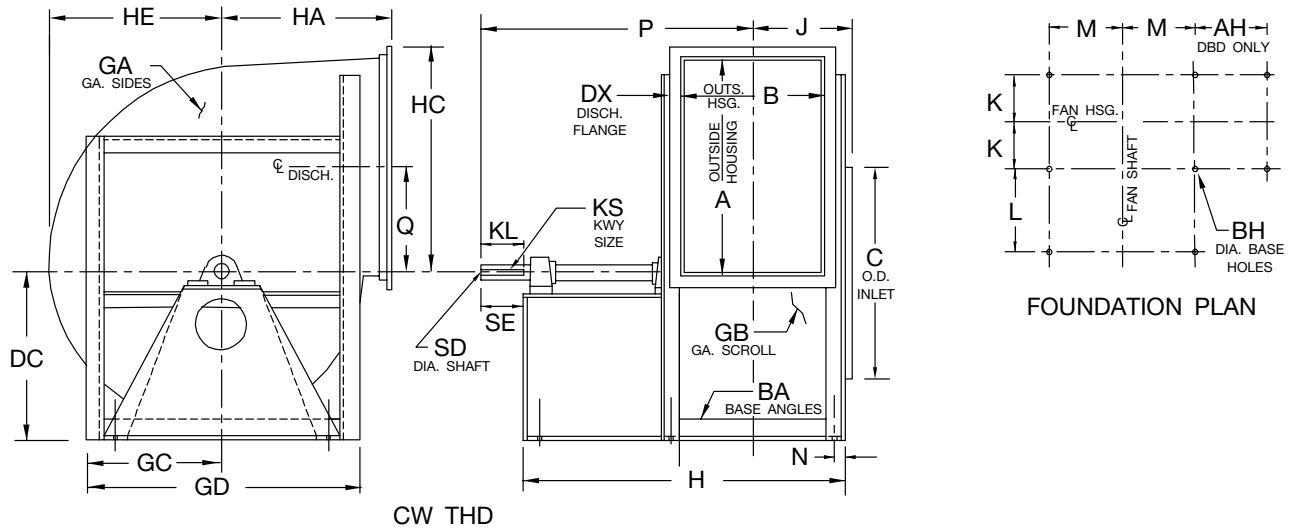

NOTES:

1. Discharge angles are included on all discharges.
2. "CW" rotation is shown. "CCW" rotation is similar but opposite.
3. For fans size 182-330 (except TAD 182-200) with inlet box at 90 degrees or 270 degrees, use "BAU" discharge dimension "DF" for centerline height.

SIZE	L	M	N	P	Q	SD	SE
122	191	165	22	481	164	38	89
135	203	181	22	508	181	38	89
150	241	203	22	573	200	45	102
165	241	222	22	589	221	45	102
182	267	245	22	656	245	45	127
200	292	270	22	699	268	50	127
222	349	292	29	797	298	50	140
245	387	321	29	884	329	60	165
270	438	353	29	960	362	60	165
300	483	397	35	1073	402	65	197
330	533	435	35	1153	445	70	197

DIMENSIONS ARE NOT TO BE USED FOR CONSTRUCTION. CERTIFIED DRAWINGS AVAILABLE UPON REQUEST.

Arrangement 1, SWSI Non-Rotatable, Class III

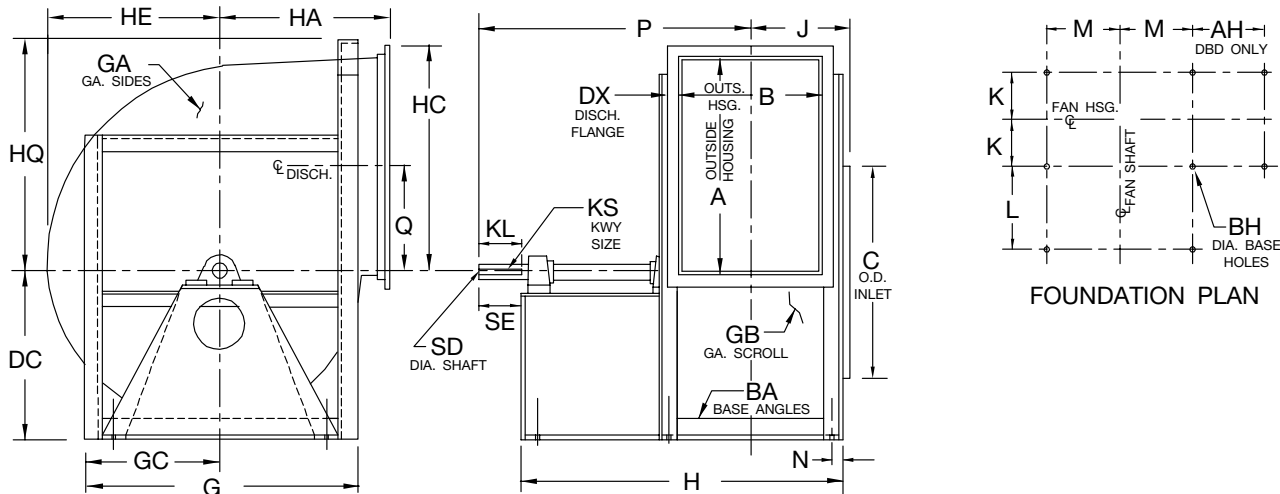

CW THD

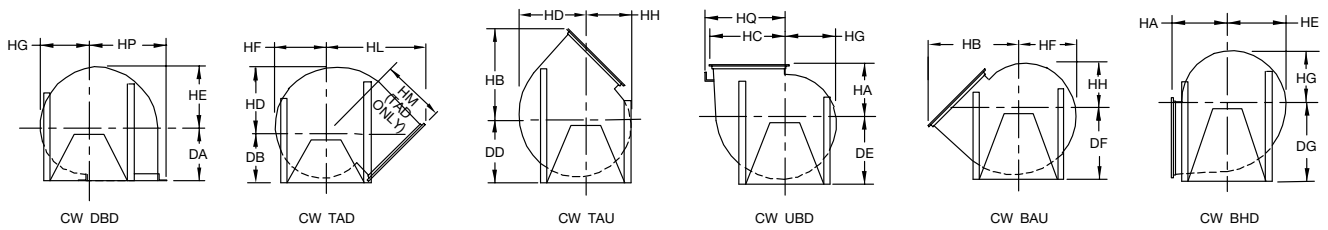

NOTES:

1. Discharge angles are included on all discharges.
2. "CW" rotation is shown. "CCW" rotation is similar but opposite.
3. For fans with inlet box at 90 degrees or 270 degrees, use "BAU" discharge dimension "DF" for centerline height.

SIZE	A	AH	B	BA	BH	C	DA	DB	DC	DD	DE	DF	DG	DX	G	GA	GB	GC
365	988	551	737	75 x 75	21	978	737	743	749	800	851	902	1054	38 x 38	1245	5	5	622
402	1087	619	811	75 x 100	21	1078	813	806	838	895	940	1003	1156	50 x 50	1334	5	5	667
445	1202	683	897	75 x 100	21	1191	899	921	902	978	1016	1099	1270	50 x 50	1435	5	5	718
490	1324	741	984	75 x 100	21	1311	991	984	991	1073	1118	1207	1391	50 x 50	1562	5	5	781
542	1462	835	1092	90 x 125	21	1451	1094	1073	1105	1181	1245	1327	1543	65 x 65	1702	5	5	851
600	1618	914	1205	90 x 125	21	1604	1211	1143	1219	1302	1372	1461	1695	65 x 65	1880	5	5	940
660	1775	1021	1329	100 x 150	21	1762	1332	1257	1334	1416	1499	1600	1873	65 x 65	2032	5	5	1016
730	1965	1110	1465	100 x 150	21	1949	1473	1378	1448	1568	1638	1765	2064	65 x 65	2235	5	5	1118
807	2173	1223	1619	100 x 150	21	2156	1630	1511	1600	1715	1829	1943	2273	65 x 65	2451	5	5	1226
890	2394	1303	1781	100 x 150	21	2372	1778	1664	1759	1873	1988	2159	2496	65 x 65	2731	5	5	1365

SIZE	H	HA	HB	HC	HD	HE	HF	HG	HH	HL	HM	HP	HQ	J	K	KL	KS CLASS I	L	M
365	1473	737	1243	1021	854	802	754	706	659	1400	959	1059	—	470	410	178	20 x 12	572	473
402	1626	813	1376	1134	941	883	830	778	725	1534	1035	1184	—	533	461	203	20 x 12	610	518
445	1788	899	1518	1248	1041	973	916	859	802	1691	1141	1299	—	576	503	203	25 x 14	686	568
490	1924	991	1669	1370	1141	1073	1010	946	883	1840	1232	1421	—	619	546	229	25 x 14	737	632
542	2083	1094	1849	1521	1267	1187	1118	1048	978	2026	1343	1584	1518	699	613	229	28 x 16	749	689
600	2273	1211	2042	1676	1399	1314	1237	1159	1081	2224	1468	1740	1683	756	670	241	32 x 18	826	765
660	2499	1332	2239	1834	1537	1445	1357	1270	1183	2411	1576	1923	1838	843	744	254	32 x 18	889	829
730	2711	1473	2473	2024	1702	1599	1503	1408	1313	2648	1721	2113	2026	911	813	267	32 x 18	965	930
807	2940	1630	2731	2232	1883	1767	1662	1557	1453	2903	1873	2321	2245	988	889	267	32 x 18	1041	1032
890	3178	1778	2991	2453	2073	1948	1832	1716	1600	3199	2070	2542	2464	1068	970	279	enq	1118	1165

DIMENSIONS ARE NOT TO BE USED FOR CONSTRUCTION. CERTIFIED DRAWINGS AVAILABLE UPON REQUEST.

Arrangement 3, DWDI Non-Rotatable, Class I & II

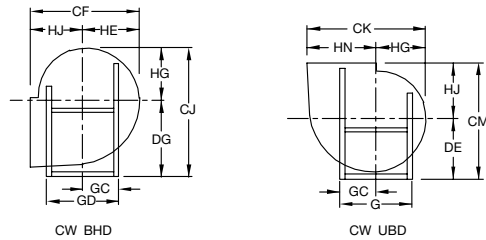
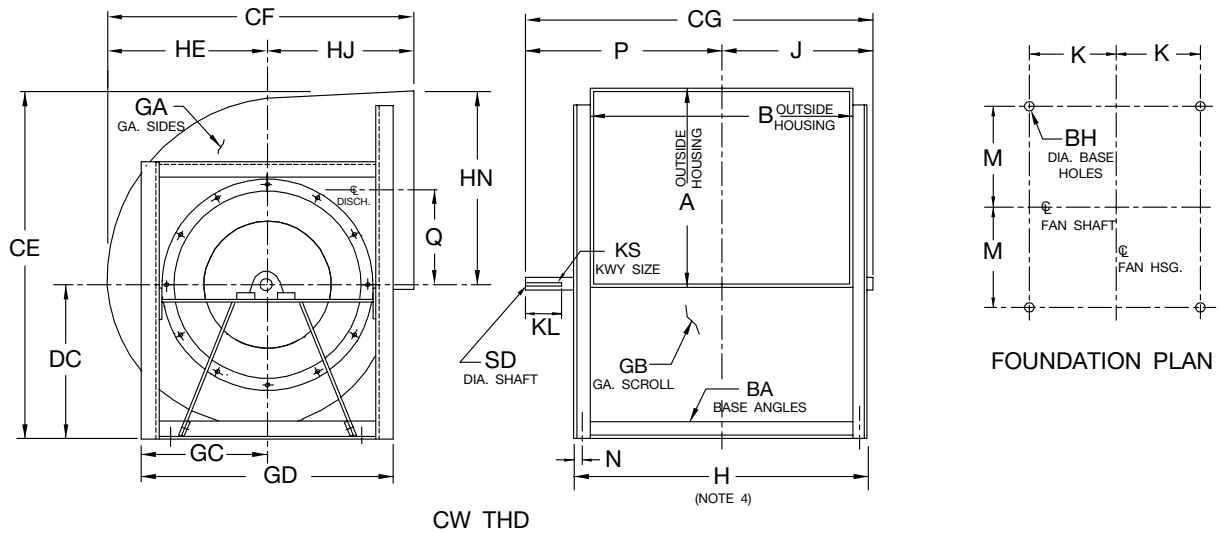

NOTES:

1. Inlet bearing bar supports are removable.
2. "CW" rotation is shown. "CCW" rotation is similar but opposite.
3. For optional flanged outlet and downblast discharge see Drawing AC14895.
4. Bearing bar supports may extend beyond base angles. See Drawing AC1000648 for dimensions if space limitations are required for mounting fan.

SIZE	A	B	BA	BH	CE	CF	CG		CJ	CK	CM	DC	DE	DG	G	GA	GB	GC
							CL I	CL II										
122	330	443	38 x 38	11	589	503	678	727	617	565	527	260	292	381	502	2.0	2.0	251
135	363	494	38 x 38	11	648	556	729	778	673	622	584	286	324	413	533	2.0	2.0	267
150	403	545	38 x 38	11	713	618	842	842	746	691	646	311	356	457	578	2.0	2.0	289
165	443	598	38 x 50	11	784	680	895	905	813	759	708	343	387	495	616	2.0	2.0	308
182	492	660	38 x 50	11	865	754	969	978	897	842	781	375	425	546	660	2.5	2.0	330
200	538	724	38 x 50	14	949	829	1032	1070	983	922	852	413	464	597	711	2.5	2.0	356
222	598	803	50 x 50	14	1054	921	1133	1191	1087	1024	957	457	521	660	794	2.5	2.0	397
245	659	884	50 x 50	14	1165	1016	1260	1289	1187	1127	1054	508	572	718	851	2.5	2.0	425
270	727	972	50 x 50	14	1284	1121	1346	1391	1307	1245	1161	559	629	787	914	2.5	2.0	457

SIZE	GD	H	HE	HG	HJ	HN	J		K	KL	KS		M	N	P		Q	SD	
							CL I	CL II			CLASS I	CLASS II			CL I	CL II		CL I	CL II
122	470	521	268	236	235	329	291	314	245	76	8 x 7	10 x 8	171	16	387	413	164	30	38
135	502	572	295	260	260	362	316	340	270	76	8 x 7	14 x 9	187	16	413	438	181	30	45
150	546	622	327	289	291	402	365	365	295	89	10 x 8	14 x 9	210	16	476	476	200	38	45
165	616	702	359	318	321	441	392	395	329	89	10 x 8	14 x 9	222	22	503	510	221	38	50
182	660	762	399	351	356	490	422	425	359	102	14 x 9	14 x 9	245	22	546	552	245	45	50
200	711	826	440	386	389	537	452	471	391	102	14 x 9	18 x 11	270	22	578	598	268	45	60
222	794	905	484	427	437	597	497	524	430	114	14 x 9	18 x 11	298	22	637	667	298	50	65
245	851	988	533	470	483	657	554	567	471	127	18 x 11	18 x 11	327	22	706	722	329	60	65
270	914	1073	589	519	532	725	597	617	514	127	18 x 11	20 x 12	359	22	749	773	362	60	70

DIMENSIONS ARE NOT TO BE USED FOR CONSTRUCTION. CERTIFIED DRAWINGS AVAILABLE UPON REQUEST.

Arrangement 3, DWDI Non-Rotatable, Class I & II (cont'd.)

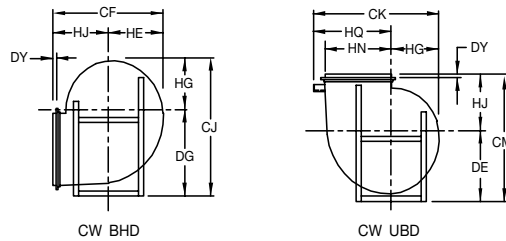
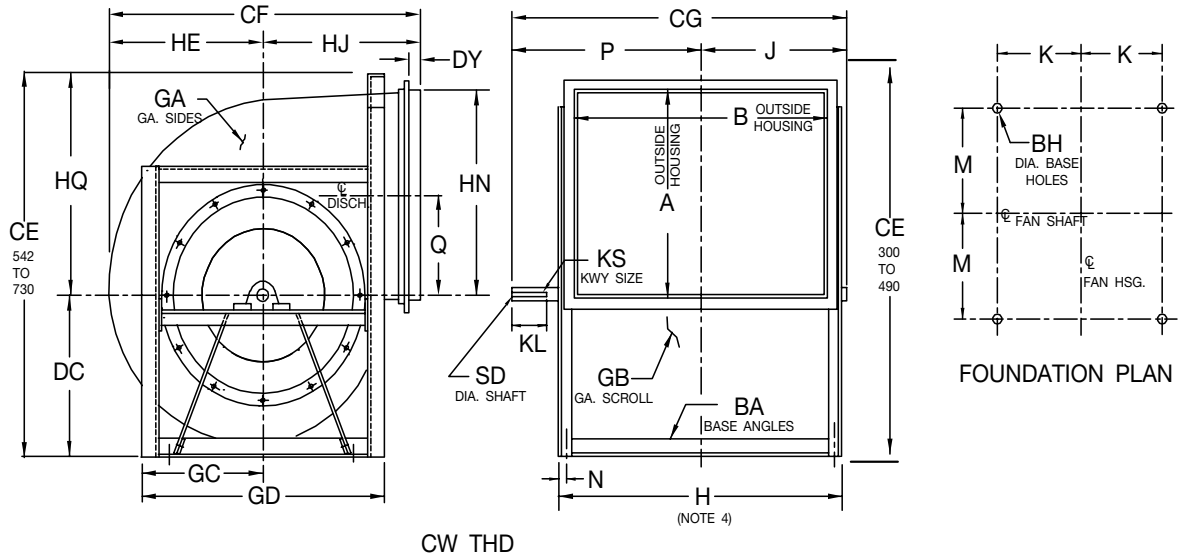

NOTES:

1. Inlet bearing bar supports are removable.
2. "CW" rotation is shown. "CCW" rotation is similar but opposite.
3. For optional flanged outlet connection and downblast discharge see Drawing AC14896.
4. Bearing bar supports may extend beyond base angles. See Drawing AC1000648 for dimensions if space limitations are required for mounting fan.

SIZE	A	B	BA	BH	CE	CF	CG		CJ	CK	CM	DC	DE	DG	DY	G	GA	GB	GC
							CL I	CL II											
300	808	1084	65 x 65	14	1467	1246	1502	1502	1448	1422	1316	622	724	870	32	1041	3.0	2.5	521
330	892	1186	65 x 65	14	1614	1375	1604	1604	1581	1564	1441	686	787	946	38	1118	3.0	2.5	559
365	983	1316	65 x 65	14	1769	1524	1750	1750	1746	1724	1575	749	851	1041	38	1219	3.0	2.5	610
402	1083	1453	75 x 75	21	1957	1681	1883	1899	1932	1895	1740	838	940	1156	38	1334	3.0	2.5	667
445	1197	1604	75 x 75	21	2135	1858	2032	2041	2127	2091	1902	902	1016	1270	38	1435	3.0	2.5	718
490	1319	1764	75 x 75	21	2359	2050	2235	2300	2335	2313	2096	991	1118	1391	38	1562	3.0	2.5	781
542	1457	1954	75 x 100	21	2623	2267	2407	2431	2577	2564	2326	1105	1245	1530	38	1702	3.0	2.5	851
600	1613	2159	75 x 100	21	2889	2512	2720	2759	2840	2827	2570	1219	1372	1683	38	1854	3.0	2.5	927
660	1770	2380	90 x 125	21	3169	2762	2942	2983	3129	3104	2818	1334	1499	1861	38	2032	3.0	2.5	1016
730	1962	2626	90 x 125	21	3473	3058	3251	3251	3459	3432	3099	1448	1638	2051	38	2235	3.0	3.0	1118

SIZE	H	HE	HG	HJ	HN	HQ	J		K	KL	KS		M	N	P		Q	SD	
							CL I	CL II			CLASS I	CLASS II			CL I	CL II		CL I	CL II
300	1213	654	578	592	806	—	667	667	578	140	18 x 11	18 x 11	403	29	835	835	402	65	65
330	1314	721	635	654	891	—	718	718	629	140	18 x 11	18 x 11	441	29	886	886	445	65	65
365	1445	800	705	724	981	—	791	791	694	140	20 x 12	20 x 12	480	29	959	959	489	70	70
402	1607	881	776	800	1081	—	851	859	768	152	18 x 11	20 x 12	530	35	1032	1040	540	65	70
445	1756	972	857	886	1195	—	926	929	843	152	18 x 11	20 x 12	581	35	1106	1113	597	65	75
490	1918	1072	945	978	1318	—	1014	1045	975	178	20 x 12	25 x 14	645	35	1221	1256	657	70	90
542	2159	1186	1046	1081	1456	1518	1111	1122	1032	152	20 x 12	25 x 14	702	48	1295	1308	727	75	90
600	2362	1313	1157	1199	1611	1670	1242	1261	1134	203	25 x 14	28 x 16	778	48	1478	1499	805	90	100
660	2635	1443	1268	1319	1769	1835	1353	1373	1257	203	25 x 14	28 x 16	842	60	1589	1610	883	90	100
730	2880	1597	1407	1461	1959	2026	1494	1494	1379	229	28 x 16	28 x 16	943	60	1757	1757	978	100	100

DIMENSIONS ARE NOT TO BE USED FOR CONSTRUCTION. CERTIFIED DRAWINGS AVAILABLE UPON REQUEST.



Model BAE-SWSI

Fans shall be Model BAE Aerofoil, as manufactured by Twin City Fan & Blower, Minneapolis, Minnesota.

PERFORMANCE — Fans shall be tested in accordance with AMCA 210 and AMCA 300 test codes for air moving devices and shall be licensed to bear the AMCA certified ratings seal for both sound and air.

Fans shall have a sharply rising pressure characteristic extending through the operating range and continuing to rise beyond the efficiency peak to ensure quiet and stable operation. Fans shall have a non-overloading design with self-limiting power characteristics and shall reach a peak in the normal selection area. All fans shall be capable of operating over the minimum pressure class limits, as specified in AMCA Standard 99-2408-69.

HOUSING — BAE fan housings shall be of heavy gauge, continuously welded construction. Housings with lock seams or partially welded construction are not acceptable. Discharge flanges are to be provided for rigidity and duct connection. Housings shall be suitably braced to prevent vibration or pulsation. Housings shall have tapered spun, aerodynamically designed inlet cones or shrouds providing stable flow and high rigidity.

Class I and II sizes 270 and smaller, excluding Arrangement 3, shall be of the rotatable design, convertible to 8 standard discharge configurations.

IMPELLER — Impellers shall be of the non-overloading type. Impellers shall have a precision spun, flat inlet cone to allow higher efficiencies over the performance range of the fan. Sizes 245 and smaller shall have aerofoil-shaped, extruded aluminum blades. Sizes 270 and larger shall have die-formed aerofoil steel blades with the option of extruded aluminum blades. All hollow blade impellers shall be continuously welded around all edges. All impellers shall be statically and dynamically balanced on precision electronic balancers to a Balance Quality Grade G6.3 (3.8 mm/s rms) per ANSI/AMCA 204 or better.

SHAFT — Shafts shall be AISI 1040 or 1045 hot rolled steel, accurately turned, ground, polished, and ring gauged for accuracy. Shafts shall be sized for the first critical speed of at least 1.43 times the maximum speed.

BEARINGS — Bearings shall be heavy duty, grease lubricated, spherical roller or adapter mounted anti-friction ball, self-aligning, pillow block type and selected for a minimum average bearing life L10 in excess of 40,000 hours at the maximum fan RPM.

DRIVE — Motor sheaves shall be cast iron, variable pitch on applications 7.5 kW and smaller, and fixed pitch on 11 kW and larger. Drives and belts shall be located external to the fan casing and rated for 150% of the required motor rating.

FINISH AND COATING — The entire fan assembly, excluding the shaft, shall be thoroughly degreased and deburred before application of a rust-preventative primer. After the fan is completely assembled, a finish coat of paint shall be applied to the entire assembly. The fan shaft shall be coated with a petroleum-based rust protectant.

ACCESSORIES — When specified, accessories such as belt guards, weather covers, access doors, companion flanges, variable inlet vanes, outlet dampers, inlet boxes, shaft coolers, shaft seals, inlet screens, etc., shall be provided by Twin City Fan & Blower to maintain one source responsibility.

When specified, fans shall be supplied with internal or nested type variable inlet vanes for impeller diameters 420 mm and larger. Cantilevered vane blades are to be used through Size 660 to minimize air performance insertion losses and noise. The operating mechanism shall be out of the inlet airstream.

FACTORY RUN TEST — All fans prior to shipment shall be completely assembled and test run as a unit at the specified operating speed or maximum RPM allowed for the particular construction type. Each impeller shall be statically and dynamically balanced in accordance with ANSI/AMCA 204 "Balance Quality and Vibration Levels for Fans" to Balance Quality Grade G6.3 (3.8 mm/s rms). Balance readings shall be taken by electronic type equipment in the axial, vertical, and horizontal directions on each of the bearings. Records shall be maintained and a written copy shall be available upon request.

GUARANTEE — The manufacturer shall guarantee the workmanship and materials for its BAE aerofoil fans for at least twelve (12) months from start-up or eighteen (18) months from shipment, whichever occurs first.



Model BC-DW

Fans shall be Model BAE Aerofoil, as manufactured by Twin City Fan & Blower, Minneapolis, Minnesota.

PERFORMANCE — Fans shall be tested in accordance with AMCA 210 and AMCA 300 test codes for air moving devices and shall be licensed to bear the AMCA certified ratings seal for both sound and air.

Fans shall have a sharply rising pressure characteristic extending through the operating range and continuing to rise beyond the efficiency peak to ensure quiet and stable operation. Fans shall have a non-overloading design with self-limiting power characteristics and shall reach a peak in the normal selection area. All fans shall be capable of operating over the minimum pressure class limits, as specified in AMCA Standard 99-2408-69.

HOUSING — BAE fan housings shall be of heavy gauge, continuously welded construction. Housings with lock seams or partially welded construction are not acceptable. Housings shall be suitably braced to prevent vibration or pulsation. Housings shall have spun, aerodynamically designed inlet cones or inlet venturies for smooth airflow into the impellers.

IMPELLERS — Impellers shall have a precision spun, flat inlet cone to allow higher efficiencies over the performance range of the fan. Sizes 245 and smaller shall have aerofoil-shaped, extruded aluminum blades. Sizes 270 and larger shall have die-formed aerofoil steel blades with the option of extruded aluminum blades. All hollow blade impellers shall be continuously welded around all edges. All impellers shall be statically and dynamically balanced on precision electronic balancers to a Balance Quality Grade G6.3 (3.8 mm/s rms) per ANSI/AMCA 204 or better.

SHAFT — Shafts shall be AISI 1040 or 1045 hot rolled steel, accurately turned, ground, polished, and ring gauged for accuracy. Shafts shall be sized for the first critical speed of at least 1.43 times the maximum speed.

BEARINGS — Bearings shall be heavy duty, grease lubricated, spherical roller or adapter mounted anti-friction ball, self-aligning, pillow block type and selected for a minimum average bearing life L10 in excess of 40,000 hours at the maximum fan RPM.

DRIVE — Motor sheaves shall be cast iron, variable pitch on applications 7.5 kW and smaller, and fixed pitch on 11 kW and larger. Drives and belts shall be located external to the fan casing and rated for 150% of the required motor rating.

FINISH AND COATING — The entire fan assembly, excluding the shaft, shall be thoroughly degreased and deburred before application of a rust-preventative primer. After the fan is completely assembled, a finish coat of paint shall be applied to the entire assembly. The fan shaft shall be coated with a petroleum-based rust protectant.

ACCESSORIES — When specified, accessories such as belt guards, weather covers, access doors, companion flanges, variable inlet vanes, outlet dampers, inlet boxes, shaft coolers, shaft seals, inlet screens, etc., shall be provided by Twin City Fan & Blower to maintain one source responsibility.

When specified, fans shall be supplied with internal or nested type variable inlet vanes for impeller diameters 420 mm and larger. Cantilevered vane blades are to be used through Size 660 to minimize air performance insertion losses and noise. The operating mechanism shall be out of the inlet airstream. Double width fans shall have interconnecting linkage to ensure operation in unison.

FACTORY RUN TEST — All fans prior to shipment shall be completely assembled and test run as a unit at the specified operating speed or maximum RPM allowed for the particular construction type. Each impeller shall be statically and dynamically balanced in accordance with ANSI/AMCA 204 "Balance Quality and Vibration Levels for Fans" to Balance Quality Grade G6.3, (3.8 mm/s rms). Balance readings shall be taken by electronic type equipment in the axial, vertical, and horizontal directions on each of the bearings. Records shall be maintained and a written copy shall be available upon request.

GUARANTEE — The manufacturer shall guarantee the workmanship and materials for its BAE aerofoil fans for at least twelve (12) months from start-up or eighteen (18) months from shipment, whichever occurs first.

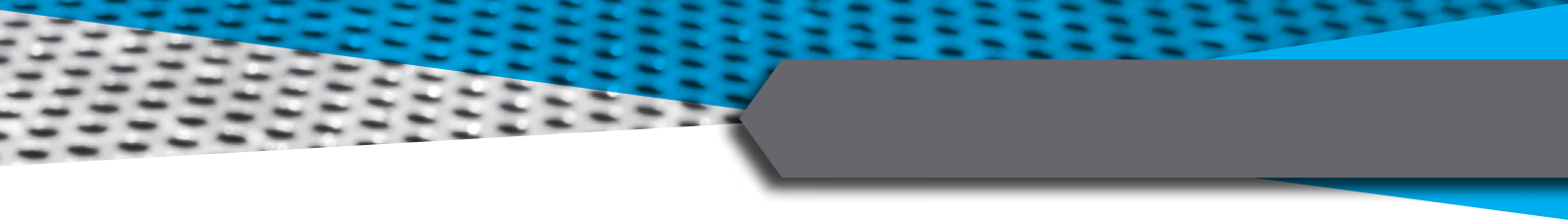

INDUSTRIAL PROCESS AND COMMERCIAL VENTILATION SYSTEMS

CENTRIFUGAL FANS | UTILITY SETS | PLENUM & PLUG FANS | INLINE CENTRIFUGAL FANS
MIXED FLOW FANS | TUBEAXIAL & VANEAXIAL FANS | PROPELLER WALL FANS | PROPELLER ROOF VENTILATORS
CENTRIFUGAL ROOF & WALL EXHAUSTERS | CEILING VENTILATORS | GRAVITY VENTILATORS | DUCT BLOWERS
RADIAL BLADED FANS | RADIAL TIP FANS | HIGH EFFICIENCY INDUSTRIAL FANS | PRESSURE BLOWERS
LABORATORY EXHAUST FANS | FILTERED SUPPLY FANS | MANCOOLERS | FIBERGLASS FANS | CUSTOM FANS



TWIN CITY FAN & BLOWER
WWW.TCF.COM

5959 TRENTON LANE N | MINNEAPOLIS, MN 55442 | PHONE: 763-551-7600 | FAX: 763-551-7601

©2018 Twin City Fan Companies, Ltd., Minneapolis, MN. All rights reserved. Catalog illustrations cover the general appearance of Twin City Fan & Blower products at the time of publication and we reserve the right to make changes in design and construction at any time without notice.